

METAL ADDITIVE MANUFACTURING TECHNOLOGY

3D PRINTER



• ENAVISION 250

• CUSTOMIZED SOLUTIONS

• ENAVISION 120

• ENAVISION 165



ERMAKSANADDITIVE
THINK 3D

www.ermaksanadditive.com

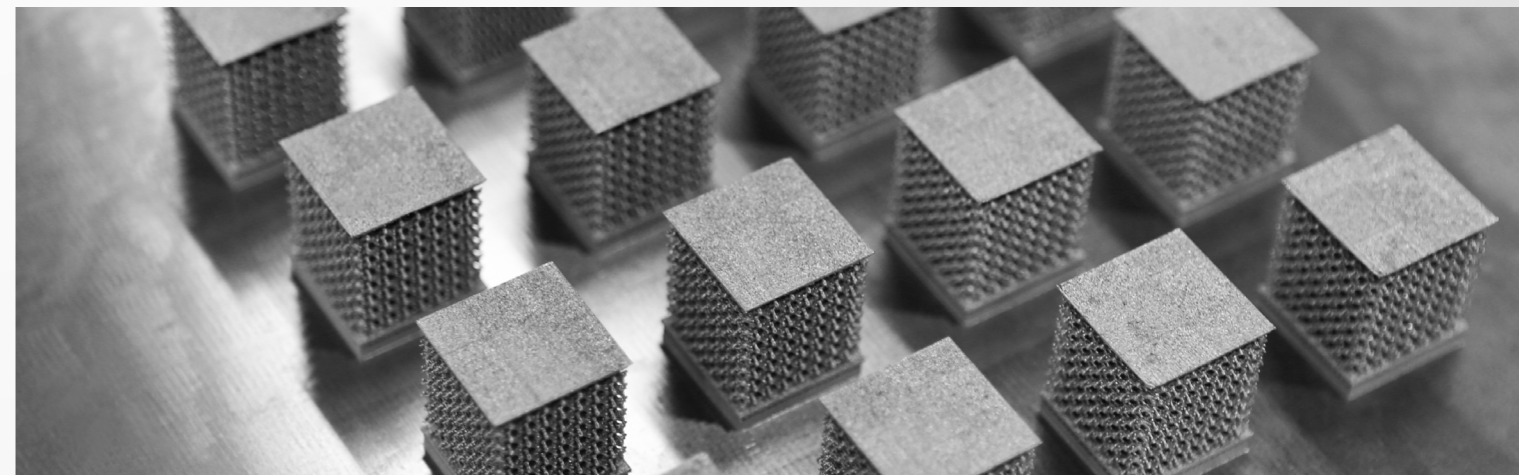
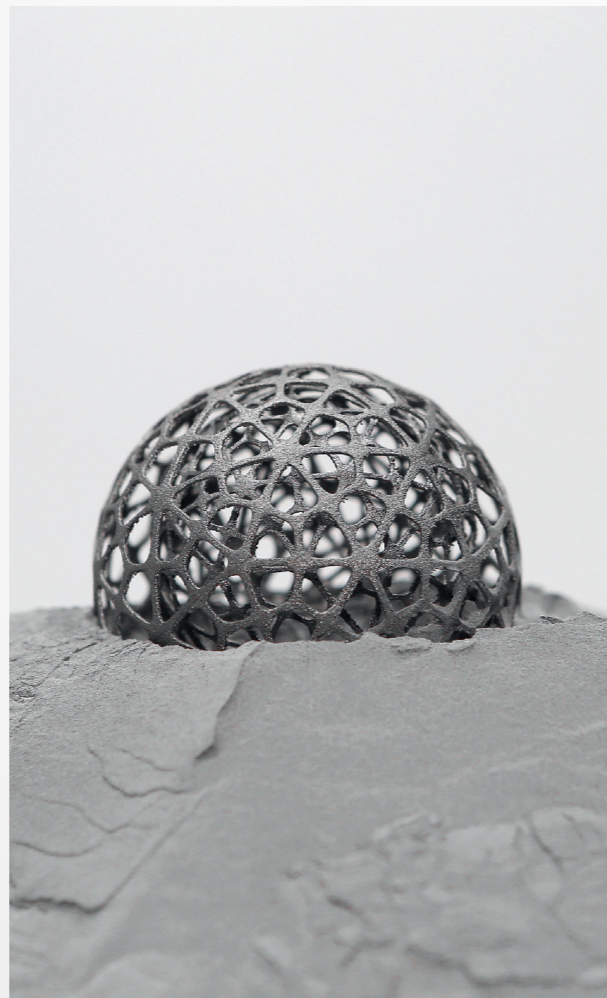
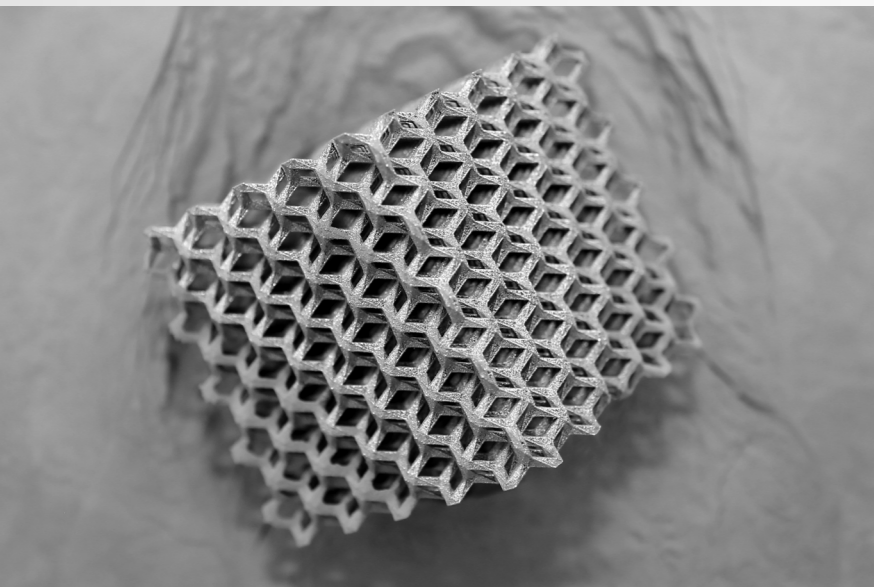
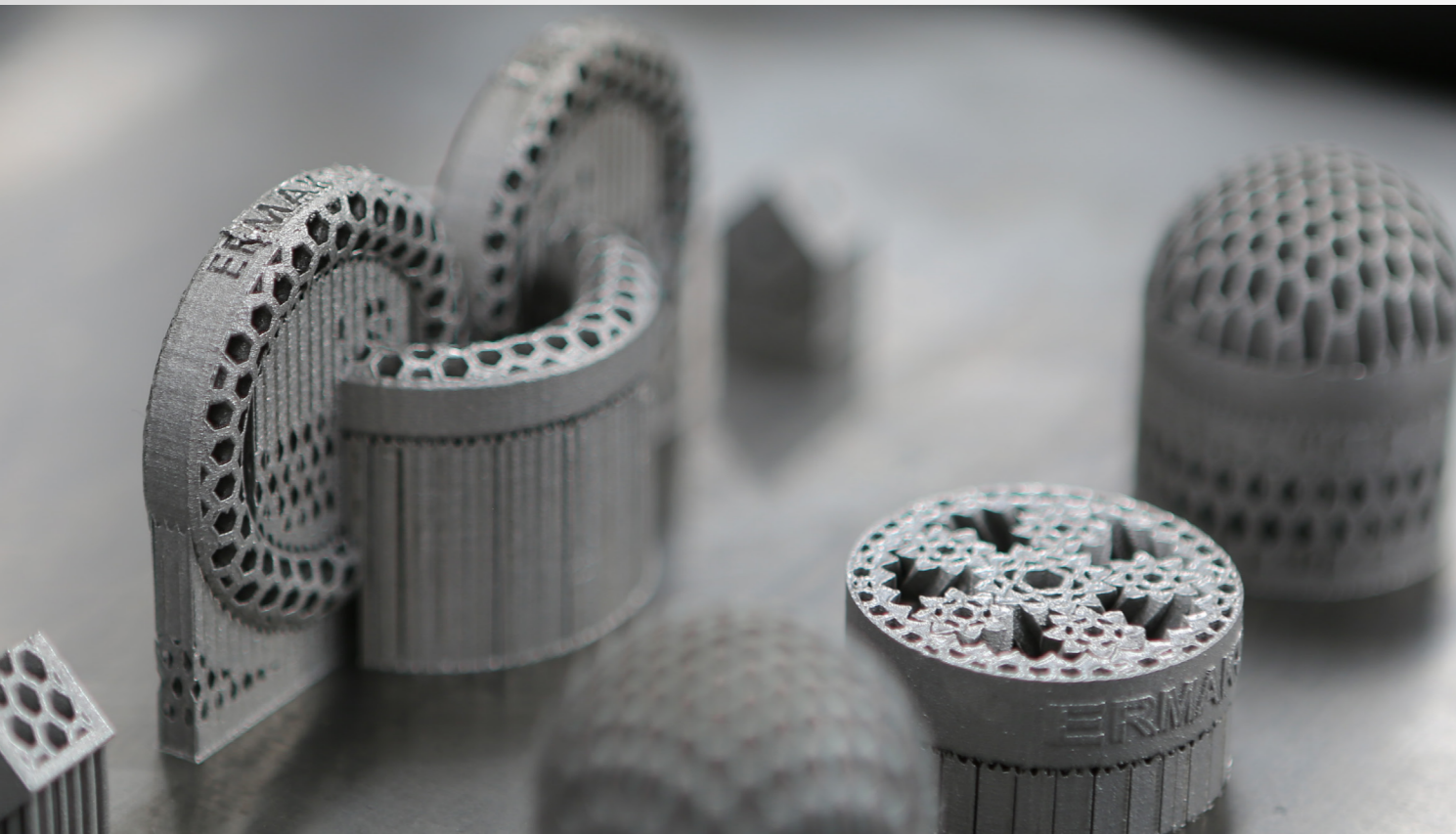

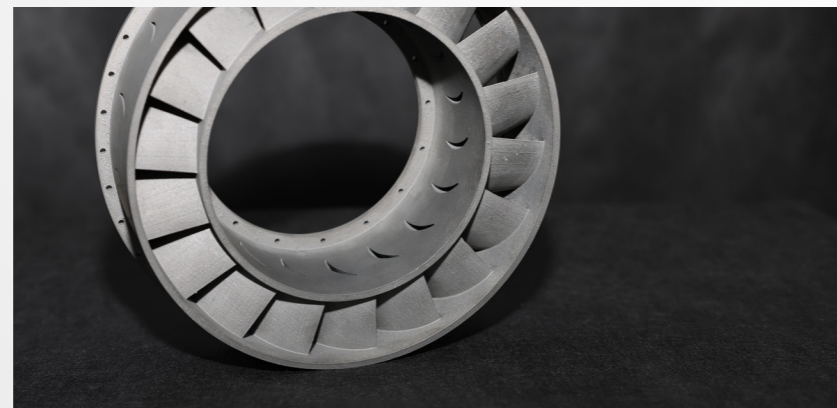
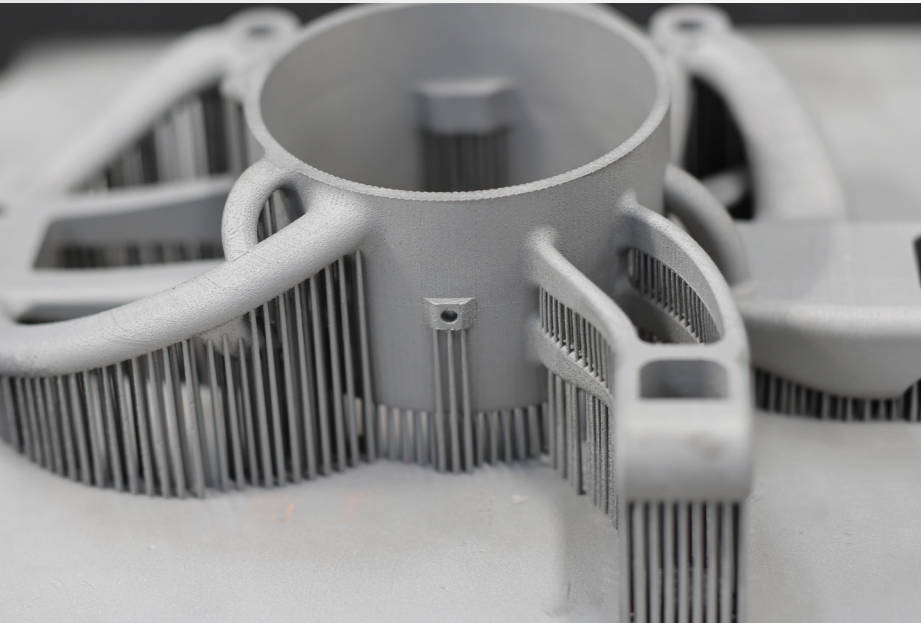
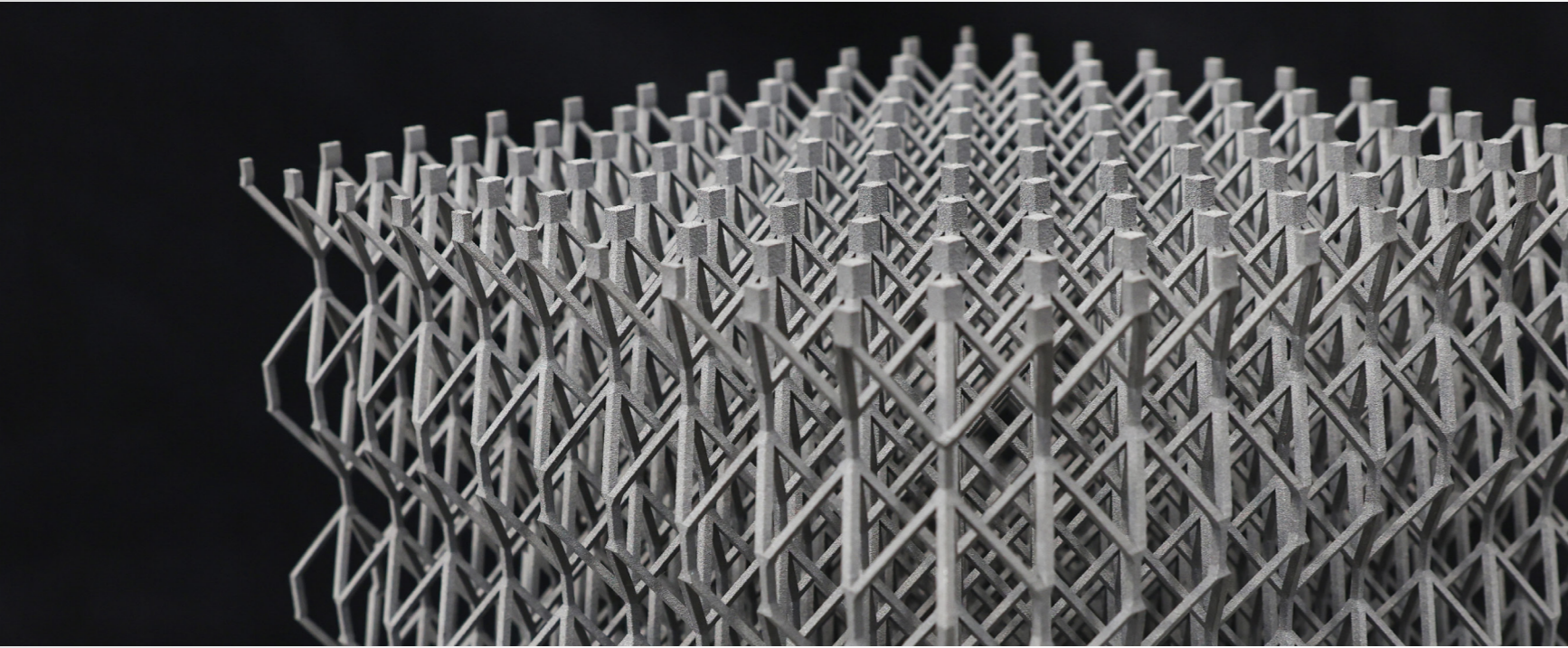

Keep One Step Ahead with Ermaksan Additive Manufacturing Technologies!

Ermaksan Additive is an entity of Ermaksan Machinery, which is the first Turkish company to produce metal 3D additive manufacturing technology.

At Ermaksan Additive, we are driven by a vision to pioneer the additive manufacturing world. With a rich heritage and an innovative spirit, we combine tradition with cutting-edge technology. Our revolutionary ENAVISION series 3D Metal Additive Manufacturing machine is reshaping industries, from aerospace and energy to automotive, molding, marine vehicles, medical, dental, hand tools, and consumer products.

Our state of the art ENAVISION machine represents not just a design revolution, but an industrial evolution. It empowers businesses with flexibility, efficiency, agility, and sustainability. This new generation technology is a cornerstone of the smart production era, offering both low cost and high efficiency in production.

At Ermaksan Additive, we provide tailored solutions in additive manufacturing to meet diverse customer needs effectively and efficiently. By adopting ENAVISION, you're not just enhancing operational excellence; you're creating new streams of revenue for your company. As you step into the future of production technology, we are committed to adding value to society and developing innovative, sustainable technologies.

Don't miss out on innovative additive manufacturing solutions that can transform your business. Explore the future with us at Ermaksan Additive. Together, let's shape a sustainable tomorrow.



YOUR PARTNER *For* ADDITIVE MANUFACTURING

PAGE **10-12**
SMALL SIZE
ENAVISION 120 & 165



PAGE **16**
MID-SIZE
ENAVISION 250



PAGE **22**
LARGE SIZE
CUSTOMIZED SOLUTIONS



PAGE **32**
POWDERS METALLURGY
POWDERS FOR ADDITIVE MANUFACTURING



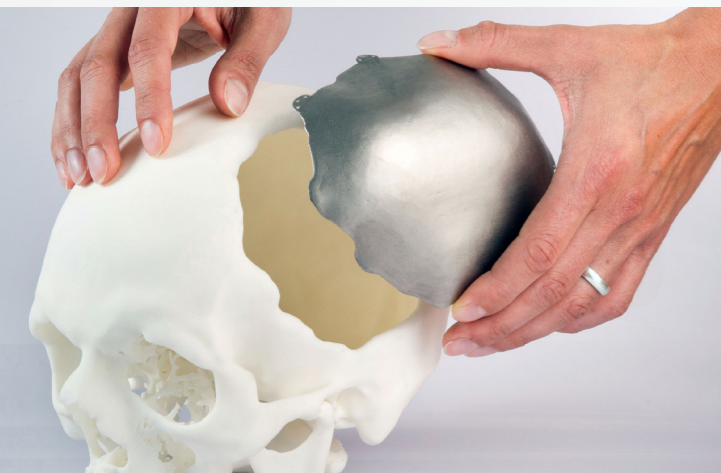

"Additive manufacturing for part production offers comprehensive solutions across various industries. It enables the production of metal parts without the need for traditional machining methods and without limitations in geometry. Initially employed in high-end technology sectors, such as aerospace applications, metal additive manufacturing has since seen widespread adoption and proven its effectiveness in industries like dental, medical, aerospace, automotive, and mold making."

MEDICAL

Ermaksan Additive is proud to provide cutting edge metal additive manufacturing solutions to the medical field. Our 3D printers enable the production of intricate and customized medical implants, prosthetics, and devices, ushering in a new era of personalized healthcare.

DENTAL

In the dental industry, precision and customization are paramount. Ermaksan Additive's metal 3D printers offer dental professionals the ability to create highly accurate dental models, crowns, bridges, and orthodontic appliances with unmatched precision and efficiency.

AUTOMOTIVE

Revolutionize your automotive manufacturing process with Ermaksan Additive's advanced 3D printing technology. Our machines can produce lightweight and durable components, optimize designs, and streamline production, enhancing performance and reducing costs.

DEFENSE AND AVIATION

For the demanding requirements of the defense and aviation sectors, Ermaksan Additive delivers robust metal additive manufacturing solutions. Our 3D printers enable the production of complex aerospace components, military hardware, and prototypes with exceptional strength and precision.

MOLDING MAKING

Ermaksan Additive empowers mold makers with innovative 3D printing capabilities. Our machines are ideal for rapid prototyping, tooling, and mold production, significantly reducing lead times and costs while maintaining high quality standards.

UNIVERSITIES AND RESEARCH INSTITUTES

Additive manufacturing revolutionizes academia, research, and industry collaborations. It strengthens university industry bonds, expedites R&D, and empowers innovation in future technologies. Ermaksan Additive empowers academic and research communities with cutting edge metal additive manufacturing technology. Our 3D printers with fully open parameter are competitive for research, materials development, and training the next generation of innovators. Partner with us to unlock new horizons in your academic pursuits.

SMALL SIZE ENAVISION 120

Print Size
Ø120x80 mm

Machine Size (LxWxH)
1200x1050x1980 mm



Machine Weight
1.000 kg

300 W Fiber Laser

ENAVISION 120

Investing in the ENAVISION 120 additive manufacturing machine provides a fast, reliable, and cost-effective solution. With its compact design and a production volume of Ø120 mm x 80 mm, ENAVISION 120 seamlessly blends practical functionality with ergonomic design. Tailored for laboratories and office environments, the new design is the perfect solution for applications in dental, medical, universities, and research institutes.

The 3D printer utilizes the Laser Powder Bed Fusion (L-PBF) method. By processing metal powders using this technology, the result is parts with a density of over 99% and excellent mechanical properties, meeting industry standards. Users have the freedom to optimize machine parameters based on part geometry and specific production needs, allowing for complete control over the process. This flexibility ensures seamless adaptation to various material types, ensuring both versatility and performance in every use case.

Furthermore, the machine's advanced features ensure consistent and reliable results. Its precise layer-by-layer deposition technology guarantees the production of complex geometries and intricate details with minimal wastage of materials. This not only reduces production costs but also contributes to a more sustainable manufacturing process.

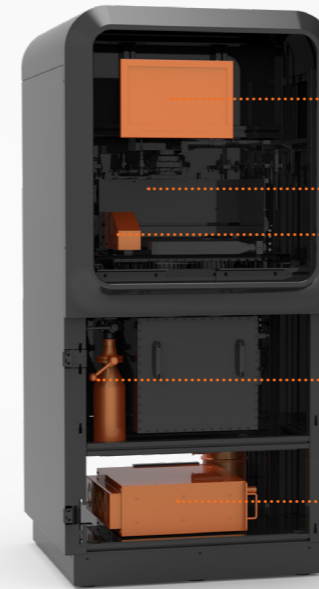

- Control Panel
- Production Site
- Powder Recoater Blade
- Powder Collecting Unit
- Resonator

Electric Panel

Filter

Pneumatic System

Blower

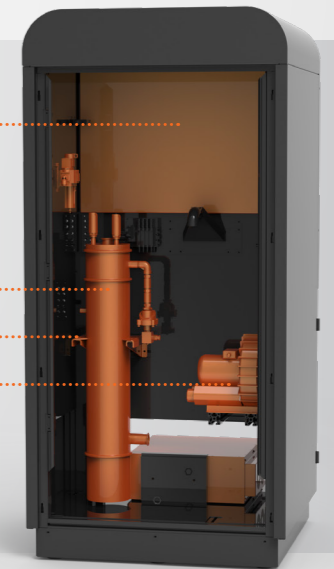

Open
Parameter

Complex
Geometries

Customized
Design

Production
Efficiency

Functional
Production

Lightweight
Parts

SMALL SIZE

ENAVISION 165

Print Size
Ø165x100 mm

Machine Size (LxWxH)
1410x1400x1880 mm



Machine Weight
1.250 kg

300 W Fiber Laser

ENAVISION 165

ENAVISION 165 boasts a Ø165 mm x 100 mm production volume and features a circular production platform. Designed for versatility, it thrives in both industrial and laboratory settings thanks to its compact and ergonomic design. This machine is tailored for maximum productivity with minimal investment costs, making it an excellent choice, especially for the dental and medical sectors. Its flexibility extends to customized applications within these industries and suits office production environments like those found in universities and research institutes.

ENAVISION 165 offers users unparalleled freedom through an open parameter structure and comes in both single and dual laser versions to cater to diverse customer needs. Users can fine tune machine parameters to match part geometry and production requirements, and they have complete control over process parameters for various material types.

Utilizing the powder bed selective laser melting method, this technology begins by depositing metal powder at the desired layer height on the production platform. A high power laser then melts the metal powder in the required areas of the part model. This process repeats for each layer until production is complete. The result is parts with a density of over 99% and excellent mechanical properties, meeting industry standards.

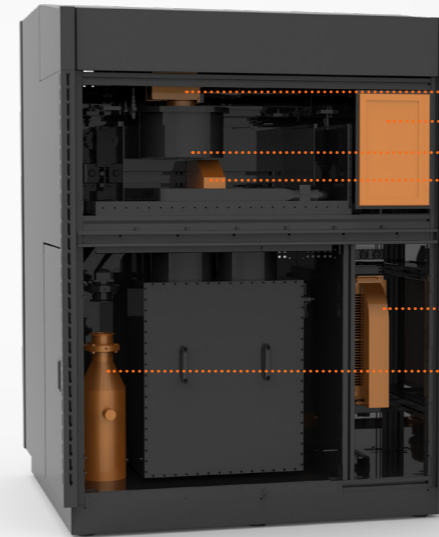

Scanning Head
Control Panel
Production Site
Powder Recoater Blade

Resonator
Powder Collecting Unit

Electric Panel

Pneumatic System

Filter

Blower



High Precision

Rapid Prototyping

Design Freedom

Cost Reduction

Time Reduction

Weight Reduction

HIGH PRECISION



FUNCTIONAL PRODUCTION



TIME TO MARKET

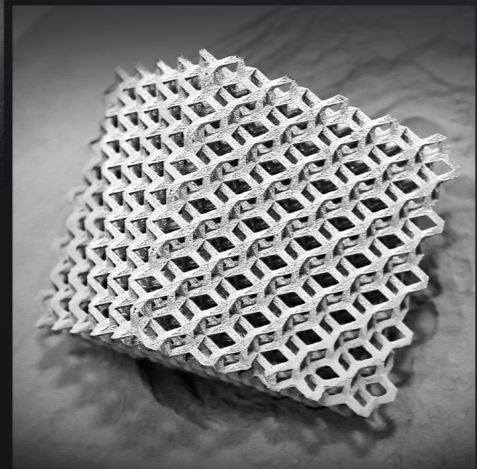

COMPLEX GEOMETRIES

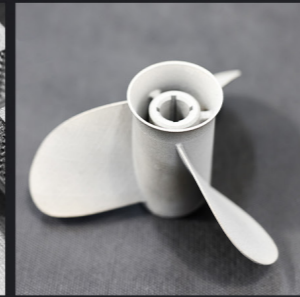
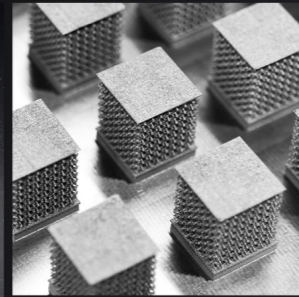

MOLDLESS PRODUCTION



CUSTOMIZED DESIGN



WEIGHT REDUCTION

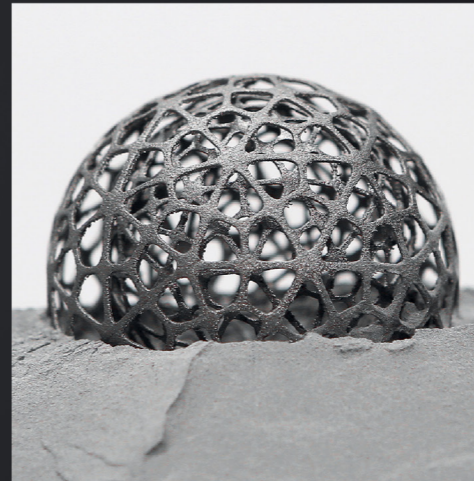

COST EFFICIENCY



RAPID PROTOTYPING

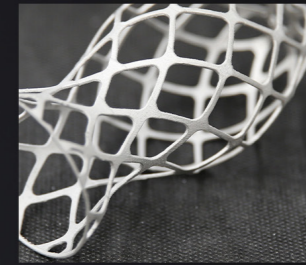

LESS ASSEMBLY

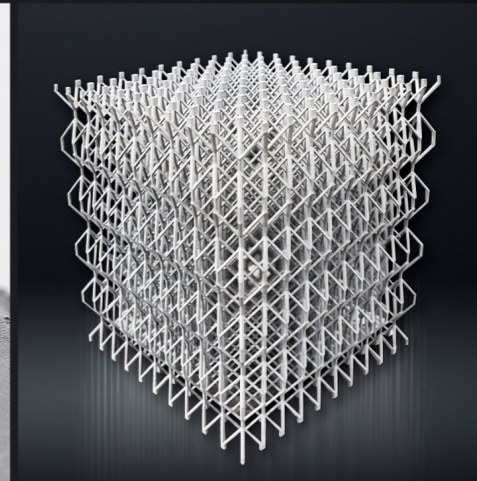

DESIGN FREEDOM



EXTREMELY DURABLE



MID-SIZE ENAVISION 250

Print Size
250x250x300 mm

Machine Size (LxWxH)
2700x1460x2350



Machine Weight
2.600 kg

500 W Fiber Laser

ENAVISION 250

ENAVISION 250, offered by Ermaksan Additive, is the solution for tackling intricate challenges in industrial settings and simplifying the production of complex geometries. With its open access architecture, it accommodates various types of powder, making it versatile across multiple sectors.

This model boasts a substantial production volume of 250 mm x 250 mm x 300 mm, providing users with unmatched flexibility and creative freedom through its open parameter structure. It comes in both single and dual laser versions to cater to diverse customer demands.

Part of the ENAVISION series, these additive manufacturing products utilize the Laser Powder Bed Fusion (L-PBF) method. The process begins by precisely depositing metal powder at the desired layer height on the build plate and then thoroughly melting the metal powder in the required areas of the part model using a high power laser. This layer by layer process continues until production is complete.

Parts manufactured through laser melting achieve a density of over 99% in standard components and exhibit excellent mechanical properties. With additional secondary processes such as heat treatment, sandblasting, drilling, threading, and machining, the produced parts can serve as final products for a wide range of applications.

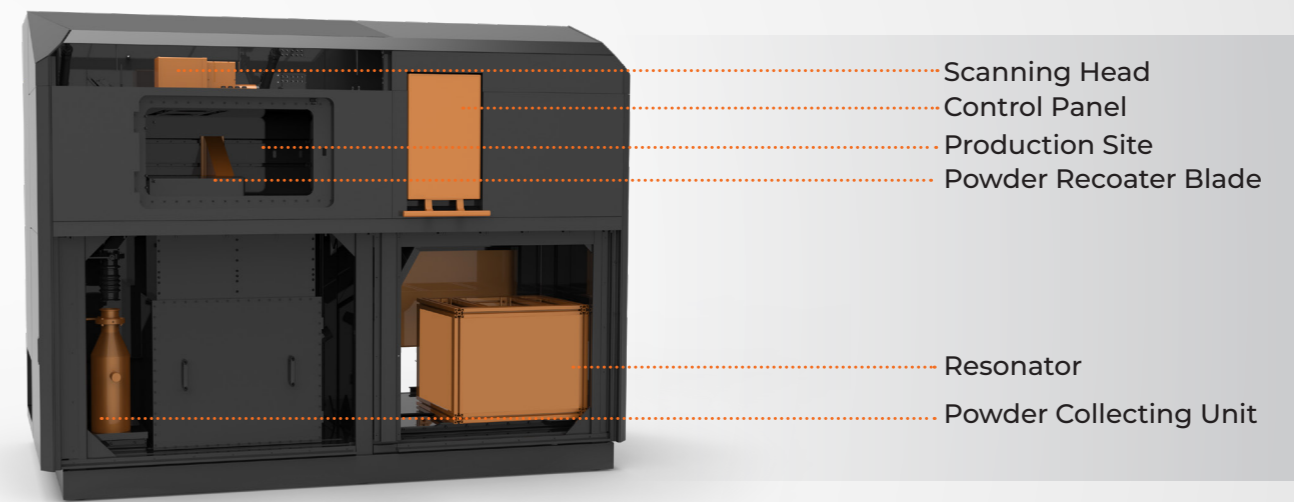

Electric Panel

Filter

Blower

Pneumatic System

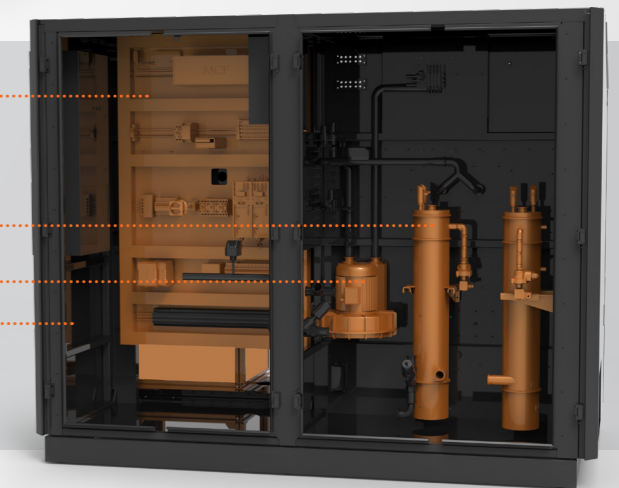

Time-to
Market

Maximum Design
Freedom

Customisation to
the Individual

Functional
Production

Lighter
Parts

Tool-Free
Production

TECHNICAL SPECIFICATIONS

	ENAVISION 120	ENAVISION 165	ENAVISION 250
PRODUCTION AREA	Ø 120 mm	Ø 165 mm	□ 250 mm
PRODUCTION HEIGHT	80 mm	100 mm	300 mm
ADJUSTABLE LAYER HEIGHT	20 - 100 µm	20 - 100 µm	20 - 100 µm
LASER TYPE	Ermaksan Fiber Laser	Ermaksan Fiber Laser	Ermaksan Fiber Laser
LASER POWER	300 W	300 W	500 W
SCANNING SYSTEM	High Speed Scan Head with F-Theta Lens	High Speed Scan Head with F-Theta Lens	3D Dynamic Focused Scanning System
SCANNING SYSTEM PIECE	1 SET	1 SET	1 SET
SCANNING SPEED (up to)	5 m/s	5 m/s	11 m/s
COOLING SYSTEM	Air	Air	Water
BUILDING PLATFORM PREHEAT	-	-	Up to 60
ELECTRICAL CONNECTION (VOLTAGE)	230 V, 1 PH, 50/60 Hz	230 V, 1 PH, 50/60 Hz	400 V, 1 PH, 50/60 Hz
ELECTRICAL CONNECTION (CURRENT)	25 / 32 A	25 / 32 A	32 A
INERT GAS	Argon / Nitrogen	Argon / Nitrogen	Argon / Nitrogen
O2 LEVEL	100-2000 ppm	100-2000 ppm	100-2000 ppm
OPERATING SYSTEM	Windows 10	Windows 10	Windows 10
NETWORK	Ethernet / Ethercat / USB	Ethernet / Ethercat / USB	Ethernet / Ethercat / USB
CONTROL SYSTEM	Beckhoff Industrial PC	Beckhoff Industrial PC	Beckhoff Industrial PC
PROCESSOR	Intel® Core™ i5	Intel® Core™ i5	Intel® Core™ i5
HMI	15.6 in, touch operated	15.6 in, touch operated	21.5 in, touch operated
DATA PREPARATION SOFTWARE	Materialise Magics and Modules	Materialise Magics and Modules	Materialise Magics and Modules
DATA PROCESSING SOFTWARE	Ermaksan Build Processor	Ermaksan Build Processor	Ermaksan Build Processor
SUPPORTED FILE TYPES	STL (3MF, AMF, DAE, FBX, VRML ...)	STL (3MF, AMF, DAE, FBX, VRML ...)	STL (3MF, AMF, DAE, FBX, VRML ...)
MACHINE LENGTH (L)	920	1410	2700
MACHINE WIDTH (W)	1120	1400	1460
MACHINE HEIGHT (H)	2000	1880	2040
MACHINE WEIGHT	1000	1250	2500

• All technical specifications can be change without any notice

CUSTOMIZED SOLUTIONS

ENAVISION 800



Customized Solutions: Meeting Unique Needs

In addition to our standard product portfolio, Ermaksan Additive provides tailored solutions for those with specialized requirements in the additive manufacturing realm. Our dedicated technical team is committed to delivering the precise additive manufacturing machine you require.

We offer turnkey solutions accommodating various configurations, from machine table dimensions to scanning models, from resonator to scanner head selection, and even specialized powder and parameter considerations. Our capabilities extend to crafting machines with non-standard narrow table sizes or expansive production tables, perfectly aligned with your specific needs.

Our solutions are adapted according to table size, offering laser resonators with varying power capacities and properties. To enhance production speed, we work closely with our customers to develop customized alternative models, including partial scanning or full scanning (covering the entire plate), often utilizing systems with multiple scanner heads.

When it comes to unique dimensions and requirements, trust Ermaksan Additive for tailored solutions that meet your precise specifications.

Print Size
800x800x500 mm

4X1000 W
Fiber Laser

Automatic Powder
Circulation System

In-Process Quality
Assurance Technology

ADDITIVE MANUFACTURING

GENERAL SPECIFICATIONS

ERMAKSAN OWN LASER RESONATOR



ERMaksan offers high-efficiency single-mode fiber laser technology developed SLM and SLS technology to our customers.

ROBUST DYNAMIC CONTROL

- Advanced technology laser control and laser driver
- Input / output units designed at industrial standards
- Flexible design control on I/O
- Control and tracking over Modbus
- Closed circuit power control management
- Superior error detection algorithm
- Ultimately efficient laser driver
- Real time control



- Highly efficient laser driver
- Critical response time
- Remote access
- High power efficiency
- Real time control
- Instant data adding
- Internal memory

EASILY PRODUCE COMPLEX GEOMETRIES

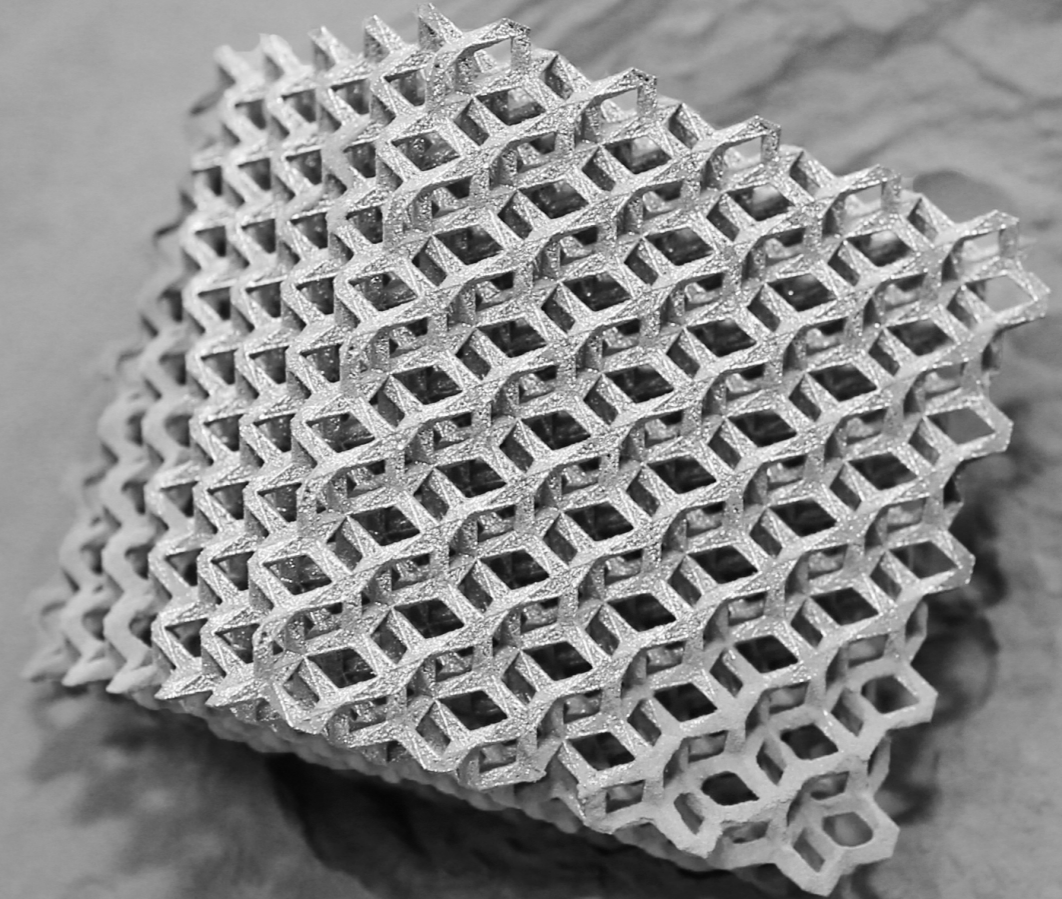

ADDITIVE MANUFACTURING EQUIPMENT

CONTROL UNIT

The industrial control unit is thoughtfully designed with advanced engineering equipment and a sleek, user friendly interface featuring a multi touch screen, ensuring ease of use.



Control unit (S)

SCAN SYSTEM (F-Theta Lens)

The scan system is equipped with an F-Theta lens, making it ideal for additive manufacturing applications and renowned for its extended lifespan. It boasts a rapid positioning speed of up to 5.0 meters per second and is compatible with the ENAVISION 120 and 165 series 3D printers.



Optical scanning system (S)

SCAN SYSTEM (3D Dynamic Focus)

The scan system is equipped with 3D Dynamic focus, making it ideal for additive manufacturing applications and known for its exceptional flexibility. It achieves a rapid positioning speed of up to 11.0 meters per second and is compatible with the ENAVISION 250 series 3D printers.



Optical scanning system (S)

VACUUM CLEANER SYSTEM

This system combines a powder vacuum cleaner with a wet separator to effectively collect metal powder laden air into a liquid filled collection tank. During this process, the metal powder mixes with both air and liquid. This system is particularly suitable for handling flammable and explosive powders and is mandatory when working with titanium and aluminum powders, ensuring safety and efficient powder recovery.



Optical scanning system (S)

COOLING UNIT

Thanks to its compact design, the highly efficient cooling unit covers a minimum area. There are 2 separate outputs for laser source (resonator) unit and optical system.



Cooling unit (S)

RECOATER SYSTEM

It is the system carrying the metal powders within the powder feeding chamber to the production chamber at any layer thickness. Since it can be adjusted sensitively, our production will be moderately sensitive, too. You can also optimize your production speed with its adjustable speed.



Recoater system (S)

PROTECTIVE EQUIPMENT

According to the method determined for part production in additive manufacturing technology, the powder particle size used varies between 20-200 μm . The powder particle sizes are at micron levels, making it easier to mix the powders into the air. The use of protective equipment in order not to be affected by the powder in the air allows the operator to make a healthier and safer production.



- Head protection system
- Anti-Static gloves
- Anti-Static carpet
- Anti-Static apron



ADDITIVE MANUFACTURING CAM SOFTWARE

PART PREPARATION SOFTWARE WORK FILE FORMATION

Magics

- Besides time assumptions, volume and cost assumptions can be made, too.
- Production order can be sent to more than one printer at the same time.
- On a single production table, more than one different/same part can be scanned at the same time and different production parameters can be applied to each of them.
- There are more formats to be realized by loading part manually.
- Different sensitivities may be required in different regions on the part surfaces. One surface can be divided into different surfaces and different mesh structures can be obtained.
- Porous indoor structures can be formed with different geometry and adjustable parameters and so the part lightens and the rigidity is protected at a certain rate.
- The surface can be divided into different surfaces and different supporting surfaces can be formed and different supporting structures can be applied to these.

Import

- By using "Magics", you can import various file formats together with the colour and format information and control your original data without losing them.
- You can import the following file formats with "Magics" RP:
 - o VRML (*.wrl, *.vrmf, *.x3dv), Rhino (*.3dm), Sketchup (*.skp), OBJ (*.obj), 3DS (*.3ds, *.prj), PLY (*.ply, *.zcp), Z-PR (*.zpr), FBX (*.fbx), COLLADA (*.dae), X3D (.x3d), 3MF (*.3mf), DXF (*.dxf), STL (*.stl)

Repair

- Frequently encountered problems can be resolved with a simple press of the 'Autofix' button.
- The 'Repair Wizard' guides you through solving complex issues, step by step.
- Model architectures can be repaired, and thickness can be added using the 'ShrinkWrap' function. (All problems can be addressed by enveloping the original model with a thin layer and compressing it.)

SUPPORT FORMATION MODULE FOR METAL 3D PRINTERS (SG+)

- You can avoid deformation with heat allocation
- You can optimize the part orientation
- You can improve the usage of powder
- You can minimize the risk of the errors that may occur during production

ERMAKSAN PRODUCTION PLATFORM SOFTWARE (ERMAKSAN P.P.)

Ermaksan Production Platform enables you to research and form the most appropriate parameter set for your process. It enables you to try more than 100 parameters and provides different scanning methods with the material development module.

- You can transfer the work file to the control unit without going to the machine.
- The control machine automatically reads the configuration and determines the physical limits of your machine.
- Enables trying different methods.

Data Processing

- Processing compensation
- Delamination and layer based data
- Layer processing
- Supports as integrated

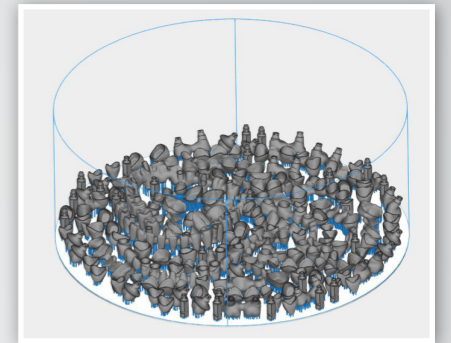

Repair wizard screen (ERMAKSAN P.P.)

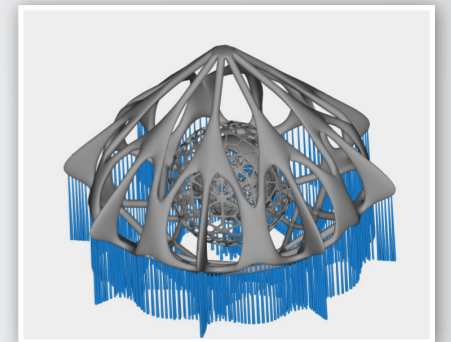

Recoater system (S)

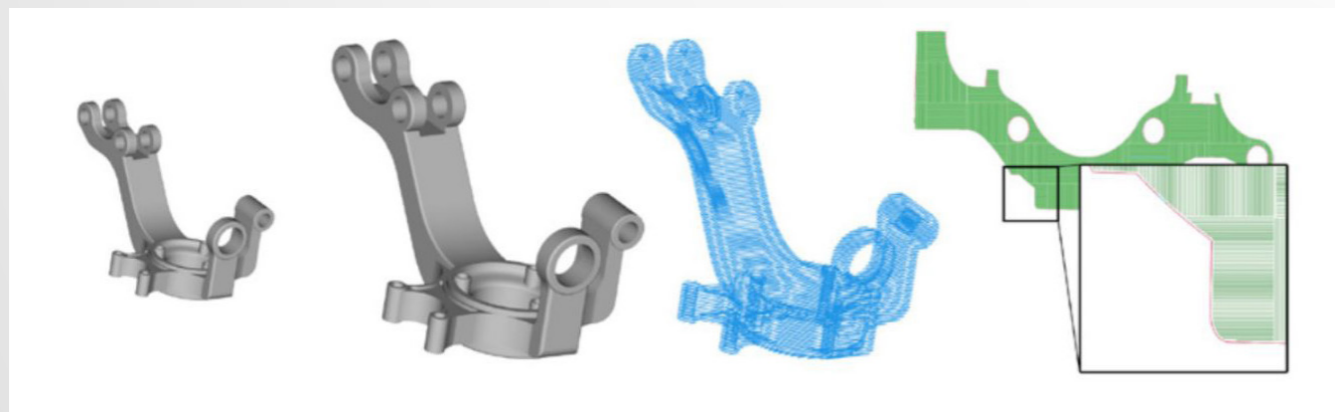

• Part Drawing

• Scaling

• Slicing

• Scanning and Ordering

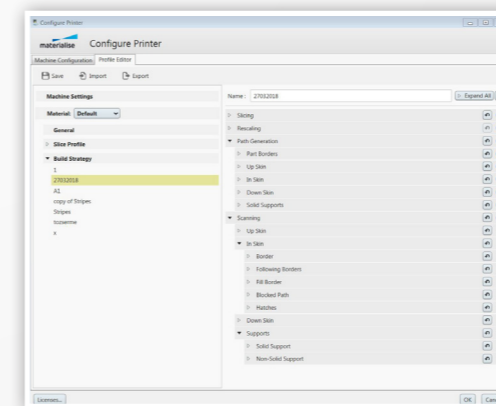

Parameter determination page (ERMAKSAN P.P.)

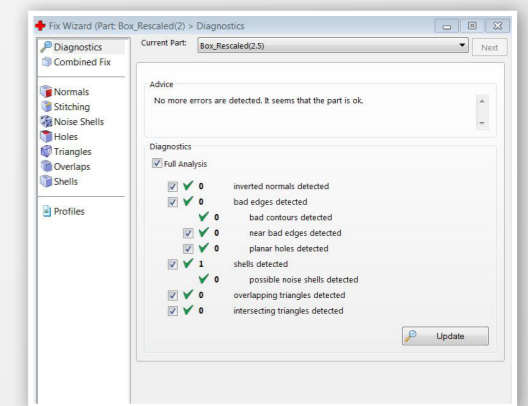

Repair wizard screen (ERMAKSAN P.P.)

OUR POWDERS ARE OPTIMIZED FOR AM



POWDER METALLURGY

POWDERS FOR ADDITIVE MANUFACTURING



METAL POWDER PRODUCTION

Together with the Ermaksan Additive team, we specialize in providing a range of tested and qualified metal powders crucial for additive manufacturing, thermal spraying, metal injection molding, and DED/laser cladding. Our portfolio includes Nickel, Titanium, Cobalt, and stainless steel metal powders, supported by essential technical expertise to ensure successful printing and production processes. We've established a rigorous materials development program aimed at certifying new materials tailored to the unique demands of additive manufacturing. Our printed materials deliver reference mechanical properties, heat treatment, and microstructure data, forming a solid foundation for further advancements.

Whether you require a material from our existing portfolio or need a custom solution to meet your specific specifications, our global engineering, sales, marketing, and logistics network is at your service. We are committed to helping you select the best materials for your unique application and stand ready to provide unwavering support throughout the process.

KEY INSIGHTS INTO OUR METAL POWDER PORTFOLIO

- ✓ Our metal powder portfolio is exclusively developed, rigorously tested, and precision-produced for optimal performance in additive manufacturing applications.
- ✓ Depending on the grade of metal based materials, we employ a process involving melting raw materials under a vacuum atmosphere, which is then remelted as needed. Our in-house metal and metal alloy powder production processes prioritize the highest product quality. This is achieved through both Vacuum Inert Gas Atomization (VIGA) and Electrode Induction Gas Atomization (EIGA) methods.
- ✓ Our metal powders are characterized by their exceptional quality, featuring high purity, spherical morphology, chemical homogeneity, tightly packed density, and excellent flow properties. These attributes are crucial for ensuring smooth and consistent production processes.
- ✓ We have fine tuned particle size distributions to meet the exacting demands of various additive manufacturing methods, including Laser Additive Manufacturing (LAM), Selective Laser Melting (SLM), Electron Beam Melting (EBM), thermal spraying, metal injection molding, and Direct Energy Deposition (DED) or laser cladding. Our tailored particle sizes are optimized to enhance the performance and efficiency of these processes.

WHY CHOOSE OUR METAL POWDERS ?

- ✓ **Exceptional Quality:** We pride ourselves on delivering top-notch metal powders that meet the highest industry standards.
- ✓ **Precision & Durability:** Our specially formulated powders offer unparalleled precision and unmatched durability. When you choose our metal powders, you're choosing materials that are engineered to perform under demanding conditions.
- ✓ **Versatility:** Our powders are designed to be highly versatile, compatible with a wide range of 3D printers. This versatility makes them ideal for various applications, ensuring you have the flexibility you need for your projects.
- ✓ **Expert Support:** We understand that success often requires more than just quality materials. That's why we provide expert guidance and technical assistance to support your endeavors. Count on us to help you navigate the intricacies of additive manufacturing and make your projects a success.



OUR ADVANTAGES

- ✓ **Decades of Expertise:** With nearly a decade of experience in materials development and manufacturing in powder metallurgy and additive manufacturing, coupled with over 60 years of experience in machine building for customers in critical applications, we bring a wealth of knowledge to every project.
- ✓ **In-House R&D Centers:** We have dedicated research and development centers equipped for testing and optimizing process parameters on various additive manufacturing metal printing machines of our own production. This ensures that our materials are tailored for peak performance.
- ✓ **Global Reach:** Our global sales and logistics network allows us to serve customers worldwide, offering seamless access to our exceptional products and services no matter where you are located.
- ✓ **Analytical Expertise:** We maintain an advanced analysis and characterization test laboratory to ensure the quality and performance of our materials consistently meet industry standards.
- ✓ **Material Traceability:** We prioritize material traceability, providing you with confidence in the origin and quality of the materials you choose.
- ✓ **Reliable Packaging:** Our commitment to quality extends to our packaging, ensuring that our products arrive in pristine condition, ready for your applications.



TECHNICAL SPECIFICATIONS

Material Base	Material Characteristic	Product	Chemistry	Particle Size Distribution (µm)
Cobalt	The parts manufactured with this powder are appropriate for the production of the surgical implants in terms of mechanical specifications and components. It is also used in the aviation applications since it is a stainless steel and temperature resistive material.	CoCrMo (F75)	Co 28Cr 6Mo	<-20, -45 +15, -53 +20, -105 + 45, -105 + 53, > +105
		CoNiCrW	Co 10Ni 24Cr 7W	
Iron	The parts that are manufactured with maraging steel powder having high yield strength and fracture toughness are ideal for aviation and injection mould productions. They are used in the gear box sets in automotive sector and production of press casting moulds in casting sector. Also, have high corrosion resistance and resistance against temperature and friction in terms of components. With these specifications, they are preferred in the production of sensitive parts in the automotive and aviation sectors.	304 (1.4307)	18Ni 8Cr	<-20, -45 +15, -53 +20, -105 + 45, -105 + 53, > +105
		316L (1.4404)	Fe 18Cr 12Ni 2Mo 0.02C	
		15-5PH	Fe 15Cr 4.5Ni 3.5Cu 0.3Nb 0.07C	
		17-4PH	Fe 17Cr 4.5Ni 4Cu 0.3(Nb+Ta) 0.07C	
		H11 (1,2343)	Fe 5Cr 1Mo 1Si 0.5V 0.4C	
		H13 (1,2344)	Fe 5Cr 1Mo 1Si 1V 0.4C	
Nickel	The parts manufactured with this powder find application in environments demanding high temperature and corrosion resistance. Widely employed in aviation and space industries, these powders are also utilized in components exposed to chemicals, tools, maritime conditions, nuclear reactor components, and rocket engine parts.	Inconel-625 (UNS N06625)	Ni 21Cr 9Mo 4Fe 4(Nb+Ta) 0.4Al 0.4Ti	<-20, -45 +15, -53 +20, -105 + 45, -105 + 53, > +105
		Inconel-718 (UNS N07718)	Ni 21Cr 9Mo 4Fe 4(Nb+Ta) 0.4Al 0.4Ti	
		Inconel-738LC (UNS R30783)	Ni 18Cr 18Fe 5(Nb+Ta) 3Mo 1Ti 0.6Al	
		Inconel-939 (UNS N0 9639)	Ni 21Cr 3,75(Nb+Tc) 4 Fe 9Mo 0.1C	
Titanium	Titanium (Ti) is a remarkable material known for its low density, approximately 56% less than steel, and its exceptional tensile strength to density ratio. Thanks to its impressive strength and outstanding corrosion resistance, titanium components find a broad range of applications. Since it is a bio compatible product particularly in the space and aviation sectors, it has a wide usage area in the medical field too. The Ti-6Al4V alloy, the world's most common titanium alloy, plays a pivotal role in various industries. At Ermaksan, we specialize in powder production for Grade 5 and Grade 23 of these alloys. Our global Ti-6Al-4V titanium alloy powder boasts global recognition, featuring low oxygen content, high density, and controlled particle size for optimal performance.	Ti6Al4V Gd-5	Ti 6Al 4V	<-20, -45 +15, -53 +20, -105 + 45, -105 + 53, > +105
		Ti6Al4V Gd-23		
Aluminum	AlSi10Mg alloy is a widely used alloy that combines light weight and good mechanical properties. Typical aluminum based alloy that offers good strength, hardness and dynamic properties, and is therefore used for parts subject to high mechanical loads. Parts made with Aluminum AlSi10Mg alloy are ideal for applications which require a combination of good thermal properties and low weight. They can be machined, spark eroded, welded, micro shot peened, polished and coated if required. AlSi10Mg metal powder for additive manufacturing (3D printing) is an excellent choice for the 3D printing of lightweight parts with good thermal properties, also as a substitution of casted parts.	AlSi10Mg	Al-Si10-Mg	<-20, -45 +15, -53 +20, -105 + 45, -105 + 53, > +105

Material (Powder)	Yield Strength (σ _a) (MPa)	Tensile Strength (σ _c) (MPa)	Elongation (%)	Density % (g/cm ³)
AlSi10Mg	260 ± 20	470 ± 35	8 ± 3	> 99,5%
CoCrMo	690 ± 20	1115 ± 35	19 ± 3	> 99,5%
Ti6Al4V	1050 ± 20	1100 ± 35	11 ± 3	> 99,5%
316L	320 ± 20	550 ± 35	42 ± 3	> 99,5%
17-4 PH	470 ± 20	930 ± 35	15 ± 3	> 99,5%
H13	470 ± 20	1950 ± 35	7,5 ± 3	> 99,5%
H11	1550 ± 20	1580 ± 35	10 ± 3	> 99,5%
INCONEL-718	725 ± 20	1050 ± 35	21 ± 3	> 99,5%
INCONEL-625	650 ± 20	950 ± 35	33 ± 3	> 99,5%

POWDER METALLURGY

EIGA AND VIGA GAS ATOMIZATION SYSTEMS

Ermaksan Additive utilizes both EIGA (Electrode Induction Gas Atomization) and VIGA (Vacuum Inert Gas Atomization) vacuum inert gas atomizers in the production of top quality metal powders. Our production process is tailored to the precise requirements of melting and atomization techniques, ensuring the production of metal powders that meet the highest quality standards.



VIGA

VIGA (Vacuum Induction Melting and Inert Gas Atomization) is the leading process for production of a variety of high performance metal powders and essential for quality manufacturing of Ni-based super alloys as well as Fe-, Co-, Cr-based powders.

EIGA

EIGA (Electrode Induction Gas Atomization) systems are exceptionally suited for transforming a diverse range of metals and special alloy electrodes into high quality metal powders. Typically, the EIGA process can convert metals and alloys with melting points up to 2500 °C into powder form. It accommodates electrodes with diameters of up to 50 mm and lengths of up to 1000 mm as feedstock. Additionally, the EIGA tower enables powder production of reactive metals without requiring a ceramic crucible.



VIGA		
Materials <ul style="list-style-type: none"> • Ni-based superalloys • Fe-, Co-, Cr-based alloys • High alloy steels • High purity Cu alloys • Precious metals and their alloys 	Markets Served <ul style="list-style-type: none"> • Aviation industry • Automotive Industry • Defense Industry Applications • Dental and Medical Applications • Research & Development 	Applications <ul style="list-style-type: none"> • Protective coatings against wear and oxidation • Feedstock for additive manufacturing technologies • Feedstock for MIM Applications

EIGA	
Materials <ul style="list-style-type: none"> • Ti and Ti alloys (TiAl6V4, TiAl) • Precious metals and their alloys • Ultra pure reactive copper and aluminum alloys • Other special metals and alloys 	Markets Served <ul style="list-style-type: none"> • Aviation industry • Defense Industry Applications • Dental and Medical Applications • Research & Development • Precious metal industry

END-TO-END SUPPLY CHAIN BASED ON ADDITIVE MANUFACTURING

As ErmaksanAdditive, we offer complete production techniques and services throughout the value chain, supporting and guiding innovation and R&D in line with our experience in materials and processing. We offer end-to-end solutions to ensure net shape production and reduce risk in the supply chain, with the goal of being your reliable and reliable business partner, starting from the production of metal powder from raw materials to design, production, characterization and finishing.

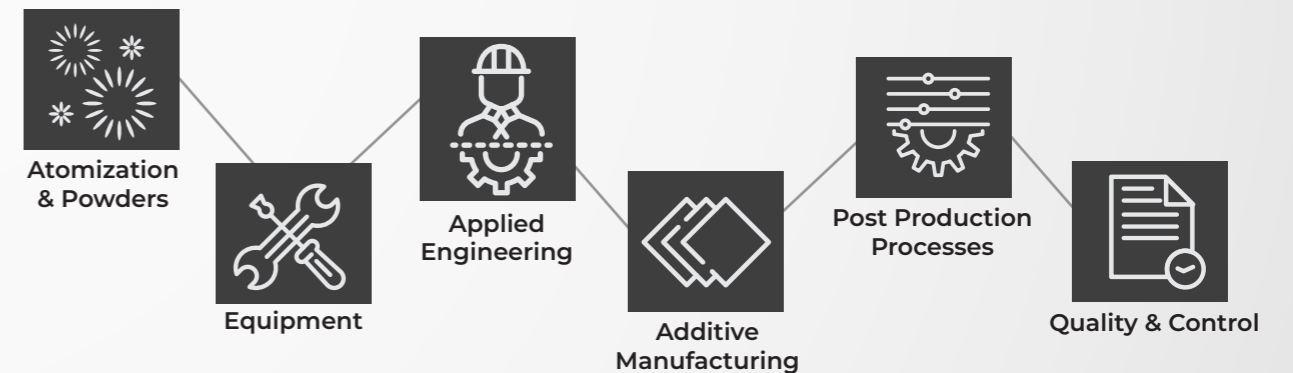

Powders produced with ERMAKSAN's VIGA systems typically have the following characteristics.

Spherical shape
Good rheological flow characteristics
High purity
High flowability
Low O, N, and H concentrations

- Annual production capacity of 50 tons for Titanium (Ti6Al4VGr5) powder
- Annual production capacity of 10 tons for Nickel Alloy (In 625 and In 718) powder
- Extensive partnerships with global companies, universities, and powder manufacturers
- Rigorous powder quality verification through our dedicated powder characterization laboratory
- Comprehensive Ermaksan assurance at every step of the process

EQUIPMENT UTILIZED IN OUR LABORATORY

Ermaksan offers various chemical and physical metal powder analysis techniques in our powder analysis facilities and all tests are carried out in accordance with ASTM as standard.

- Tap density (ASTM B527)
- Hall flow (ASTM B213) Carney flow (ASTM B964)
- Particle by Laser Size Diffraction (ASTM B822) size distribution
- Particle size distribution by Laser Size Diffraction (ASTM B822)
- Powder imaging (SEM)
- Oxygen, nitrogen, and hydrogen analysis by Inert Gas Fusion
- Elemental analysis/contamination screening (EDX)
- Chemistry- Full chemical analysis by ICP-OES
- Apparent / bulk density (measurement according to ASTM B212)
- Carbon and Sulfur chemical composition analysis
- Chemical composition analysis is carried out in accordance with ASTM E354 standard.
- C, S, N, O and H composition analysis is carried out in accordance with ASTM E1019 standard.
- Flow test (Hall and Carney) - Apparent density measurement is carried out in accordance with ASTM B212 or ASTM B417 standards.
- Tap density measurement is carried out in accordance with ASTM B527 standard



Particle Size Analyzer



Microwave Digestion Systems for Sample Preparation



Archimed Density Analyzer



Tapped Density Measurement



ICP-OES

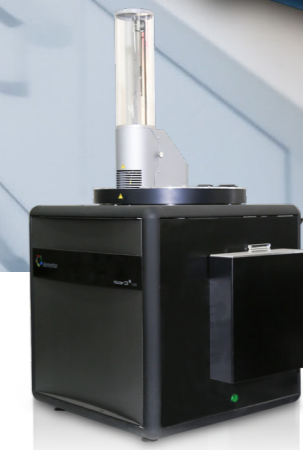

O-N-H



C-S

SMALL TO LARGE

TOGETHER AT EVERY SCALE



WEBSITE



in ermaksanadditive

f ermaksanadditive

@ ermaksanadditive



Işıktepe OSB Mah. Lacivert Cad. No:7 16065 Nilüfer | Bursa | Türkiye
T : +90 224 294 75 00 F : +90 224 294 75 44
www.ermaksanadditive.com / info@ermaksanadditive.com



Işıktepe OSB Mah. Lacivert Cad. No:8 16065 Nilüfer | Bursa | Türkiye
T : +90 224 294 75 00 F : +90 224 294 75 44
ermaksan.com.tr / sales@ermaksan.com.tr



2860 River Road, Suite:145, 60018 Des Plaines, Illinois
T : +1 630-512-7604 ermakusa.com / info@ermakusa.com

* EN * AM V1.1 / 23 / Catalogue information is subject to change without notice.