

HAT SONU ÇÖZÜM UZMANI

ROBOTİK OTOMASYON

PALETLEME

STREÇLEME

KONVEYÖR

İKİNCİL PAKETLEME

ARAŞTIRMA VE GELİŞTİRME



Optimak STU

*Robotik Otomasyon & Hat Sonu
Çözüm Uzmanı*



Optimak STU
Robotik Otomasyon & Hat Sonu
Çözüm Uzmanı

OPTİMUM SÜREÇ TASARIMI VE UYGULAMALARI LİMİTED ŞİRKETİ

Firmamız 2012 yılı mayıs ayında kurulmuş genç bir firmadır. Kurulduğu günden bu güne kadar, sanayi ve endüstrinin bir çok alanında iş görme kabiliyet ve kapasitesine sahip olmasına rağmen, tek bir konuda uzmanlaşarak, bu konuda hızlı, verimli ve yüksek kaliteli işler üretmeyi hedeflemiştir. Bugün itibariyle bu hedefini, büyük ölçüde gerçekleştirmeyi başaran firmamız, konusunda bir marka olma yolunda emin adımlarla ilerlemektedir.

1. Kolileme grubu

- Koli açma ve hazırlama makineleri
- Kartezyen kolileme robotları
- Robot arm (kol) kolilemeler
- Koli kapama makineleri

2. Koli ve paket taşıma sistemleri (çeşitli ürün taşıma konveyörleri)

3. Paletleme sistemleri

- Robotik paletleme sistemleri
- Konvansiyonel paletleme sistemleri
- Hibrit paletleme sistemleri

4. Streç sarma makineleri ve palet barkod robotları

- Hat tipi tam otomatik makineler (kollu ve döner platformlu)
- Yarı otomatik makineler (kollu ve döner tablalı)
- Hat tipi tam otomatik barkod yapıştırma ve okuma robotları

5. Palet taşıma sistemleri

- Rulolu ve zincirli konveyörler
- Döner platformlu ve kartezyen konveyörler
- Şatıl tipi konveyörler
- Palet taşıma asansörleri ve liftleri



Pirahmetler Mah. D-100 Yanyol
No: 247 Erenler / Sakarya
Tel: 0 264 353 52 53
Fax: 0 264 353 51 53
info@optimak.com.tr
www.optimak.com.tr



Optimum STU

AR-GE Merkezi

OPTIMUM SÜREÇ TASARIMI VE UYG. SAN. TİC. LTD. ŞTİ. – AR-GE MERKEZİ

Optimum STU Ar-Ge Merkezi 19.06.2018 tarihinde Sanayi ve Teknoloji Bakanlığı'nın onay vermesi ile Ar-Ge Merkezi olmuştur.

Ar-Ge merkezimizin kurulma amacı ülkemize ithal edilen orta/yüksek teknoloji ürünü makine ve yazılım vb. gibi ürünlerin ithalatını durdurmakve orta uzun dönemde ihracatını gerçekleştirmektir.

Üniversite ve diğer Ar-Ge kuruluşlarıyla yakın iş birliği içerisinde olarak, ülkemizde bilgi birikiminin artmasına katkı sağlamaktayız.

Türkiye'deki e-devlet ve e-dönüşüm projelerinde gerek askeri gerek sivil alanlardaki üreteceğimiz teknolojiler ile pay sahibi olmak istemekteyiz.

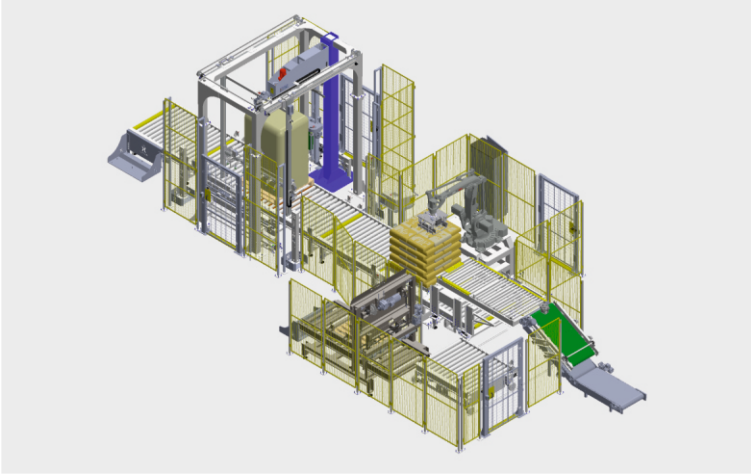

Faaliyetler

Üniversite-Sanayi iş birlikleri

Yurtdışı Ar-Ge ortaklık çalışmaları

Yurtiçi ve Yurtdışı fuarlarda ülkemizde geliştirdiğimiz teknolojilerin sergilenmesi

Patent çalışmaları

Tescilli markalar

Akademik yayınlar

Sektörel dergilerde yayınlar

Kritik teknolojiler odak grup çalışmaları

Konferans, seminer, panel katılımları



KARE KOD
ŞİRKET BİLGİLERİ
E-KATALOG

Kolileme - Paletleme - Streçleme Hattı

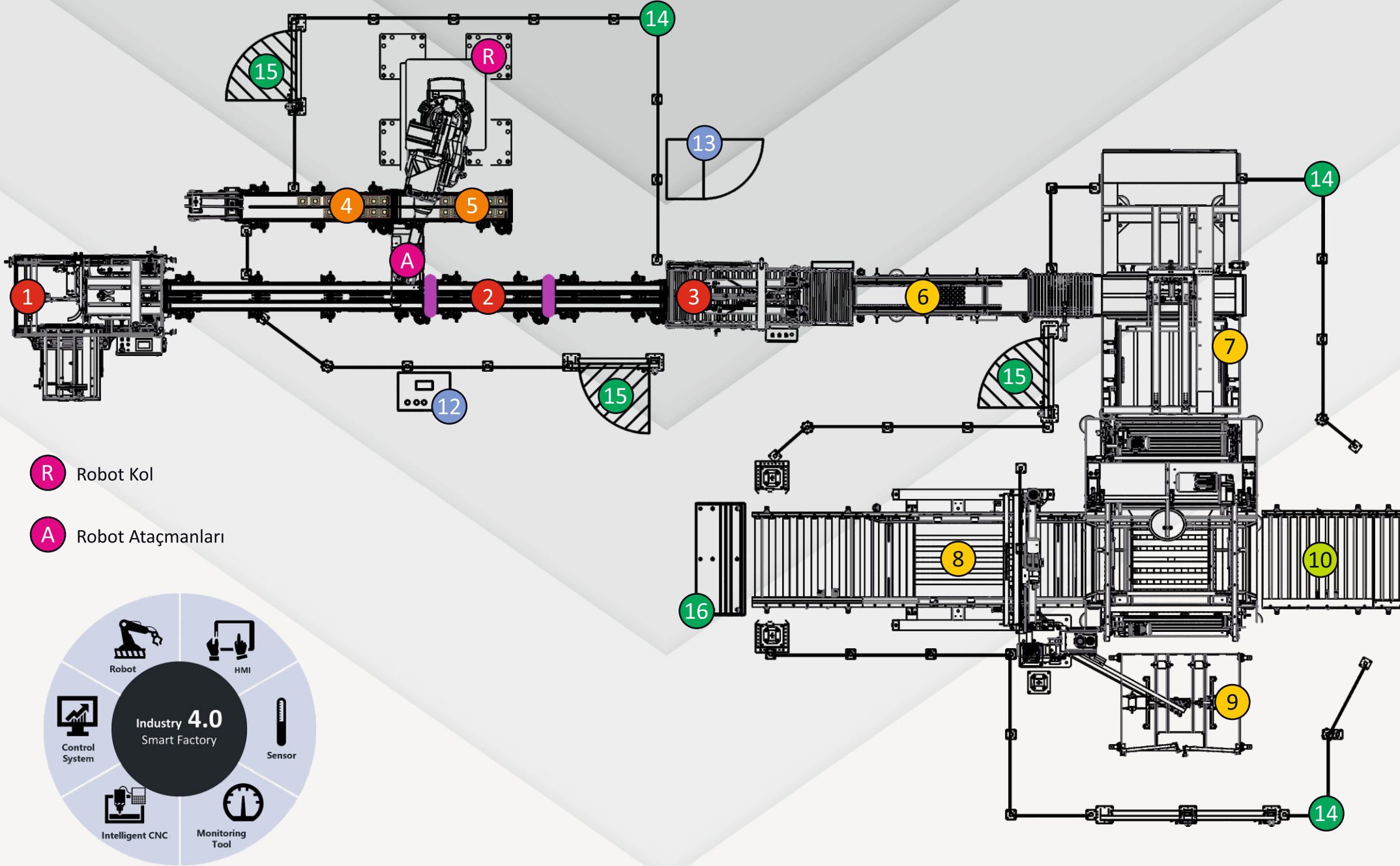

 ROBOTİK UYGULAMALAR

 KONVEYÖR SİSTEMLERİ

 STREÇ SARMA SİSTEMLERİ

 KOLİLEME SİSTEMLERİ

 PALETLEME SİSTEMLERİ

 AR-GE ÇALIŞMALARI

- 1 Koli Açma
- 2 Koli Hazırlama-Kolileme-Koli Çıkış Konv.
- 3 Koli Kapatma ve Bantlama
- 4 Divider ve Ürün Former
- 5 Ürün Hazırlama Layerı
- 6 Ürün Giriş Konveyörü
- 7 Palletizer
- 8 Palet Magazini
- 9 Separatör Magazini ve Robotu
- 10 Palet Taşıma Konveyörü
- 11 Streç Sarma Makinesi
- 12 Kiosk Paneller
- 13 Elektrik ve Control Paneli
- 14 Güvenlik Fensleri
- 15 Güvenlik Kapıları
- 16 Forklift Bariyerleri
- 17 Işın Bariyerleri

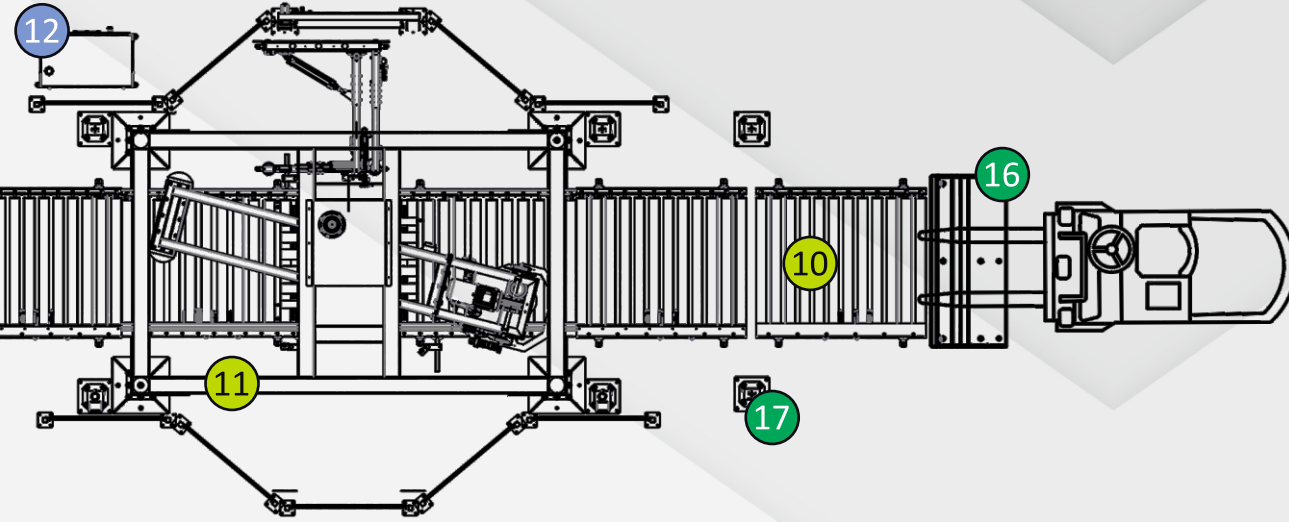

“Büyük Türkiye İçin Yerli ve Milli Teknoloji Üretiyoruz.”



Koli Açma - Kapatma - Bantlama Sistemleri



- Koli Açma ve Alt Bantlama
- Koli Alt ve Üst Bantlama
- Koli Kapatma ve Üst Bantlama
- Kartezyen Kolileme
- Robotik Kolileme
- Checkweigher
- İnkjet Sistemleri
- Barkod / Karekod Sistemleri



ÖRNEK KOLİLEME
ALT-ÜST BANTLAMA,
DOLUM İSTASYONU
ROBOTİK DOLUM
VİDEOLARI İÇİN
KARE KODU OKUTUN.



Robotik Kolileme ve Paletleme Sistemleri

Robotik Uygulamaların Avantajları

- Personele bağılı olmayan standart kalite ve miktarda üretim
- Sezonal dalgalanmaya bağılı olmayan standart üretim ve satış gücü
- Yüksek verimlilik
- Minimum işletme alanı
- Mevcut işletme alanına uygun yerleşim
- Değişen ve gelişen şartlara hızlı adaptasyon imkanı
- Bir robotla eş zamanlı birden fazla uygulama imkanı
- Yüksek kapasiteli hatlarda dar boğaz oluşumunu önler.
- Yüksek ağırlıklar yüzünden iş güvenliği ve işçi sağlığını korur.
- Hattın uzun süre sorunsuz çalışması için yüksek kalite ve teknoloji ile üretilmiştir.
- Tehlikeli kimyasalların taşınmasında insan faktörünü ortadan kaldırır, bu yüzden işçi sağlığını korur.
- Devamlı tekrarlanan işler yüzünden oluşan işçi sağlığı faktörünü ortadan kaldırır

100 - 1500
PAKET / SAAT



**ROBOTİK
PALETME-RACK-VİYOL
VİDEOLARI İÇİN
KARE KODU
OKUTUN.**



Robotik Paletleme Sistemleri



Polikarbon Damacana Robot Hattı
Paletleme ve Palet Bozma



Cam Damacana Robot Hattı
Paletleme ve Palet Bozma

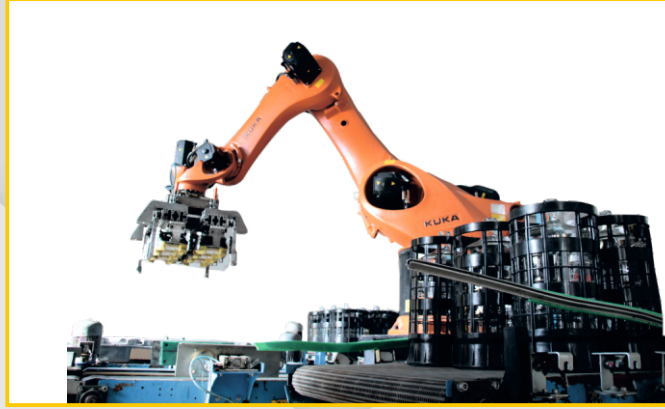

Polikarbon Damacana Rack Hattı
Palet Bozma ve Palet Yıkama



Pet Damacana Paletleme Hattı



Tam Layer Paletleme Hattı
(Tüm Ürünler İçin Kullanılabilir.)



Pet Şişe Paletleme Hattı

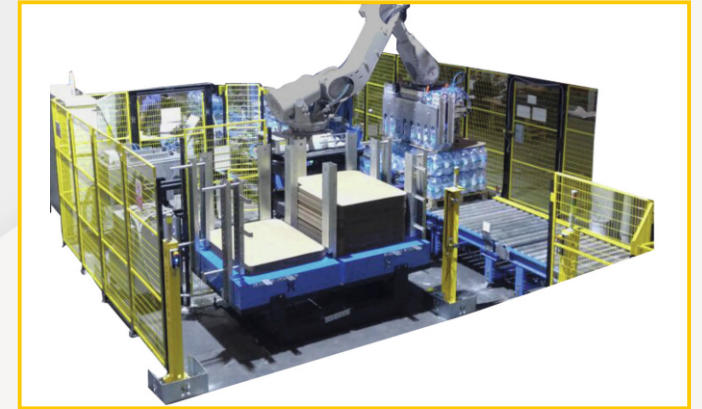

Koli Paletleme Hattı



Hibrit Paletleme (Koli ve Pet Şişe)



Çok Amaçlı Çatal Paletleme

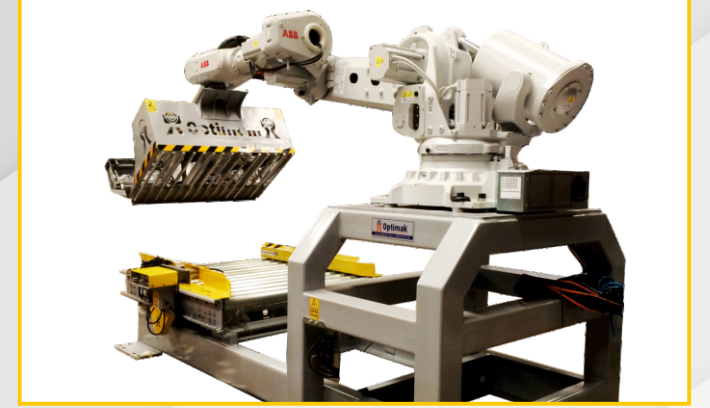

Torba Paletleme Hattı

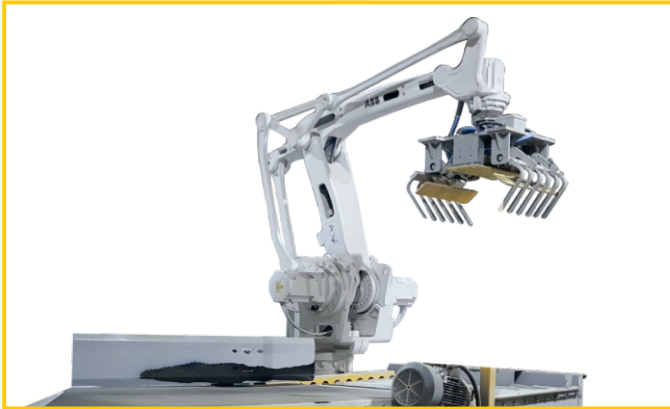

Robotik Uygulama Ataçmaları ve Kullanım Alanları

Tutma Ataçmanı

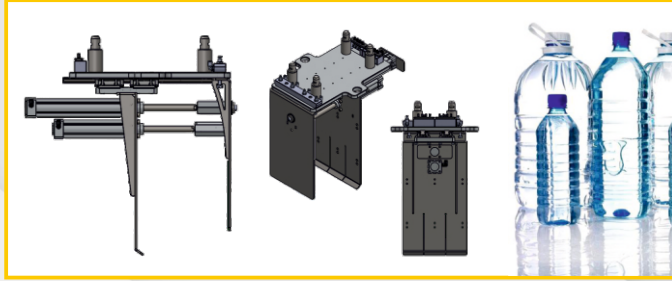

- Şirinkenmiş Ürün Paletleme
- Su, Sıvı Yağ, Gazlı İçecek vb.

Kova Ataçmanı

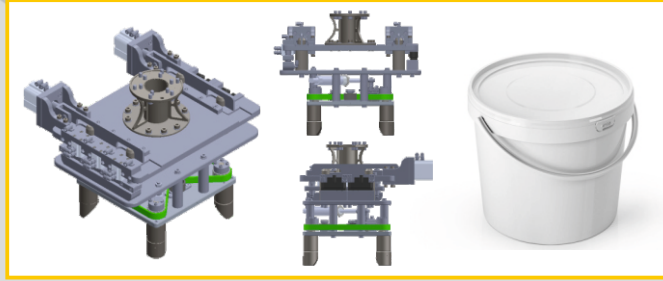

- 2,5 Kg. - 25 Kg. Kova Paletleme - Palet Bozma
- Yoğurt, Boya, Çeşitli Katkı Kimyasalları, Yapıştırıcılar vb.

Vantuz Ataçmanı

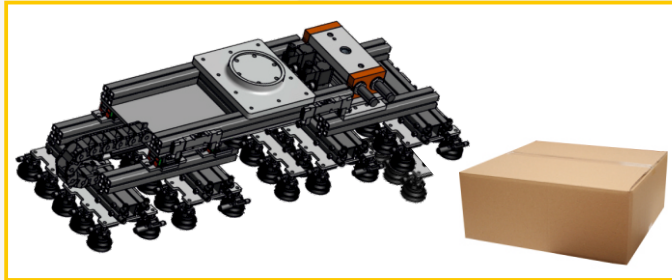

- Düz yüzeyli ürünler için idealdir. Geniş alanlı, hafif ürün tercih edilir.
- Koli, Karton, Separatör, Teneke, vb.

Manyetik Ataçman

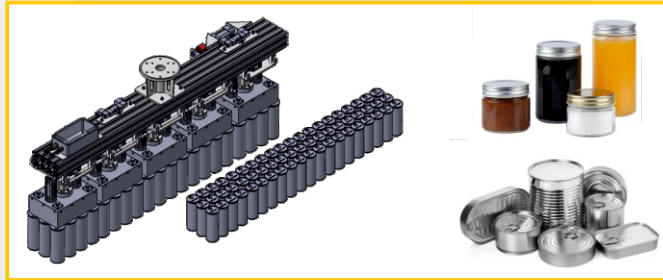

- Kutu içine konulacak konserve ve benzeri komple metalden üretilmiş veya metal kapaklı ürünlerde kullanılır.
- Tüm konserve ürünler ve metal kapaklı kavanozlar, şişeler.
- Aç-tüket tarzı konserveler, balık konservesi, reçel kavanozu, kutu içecekler vb.

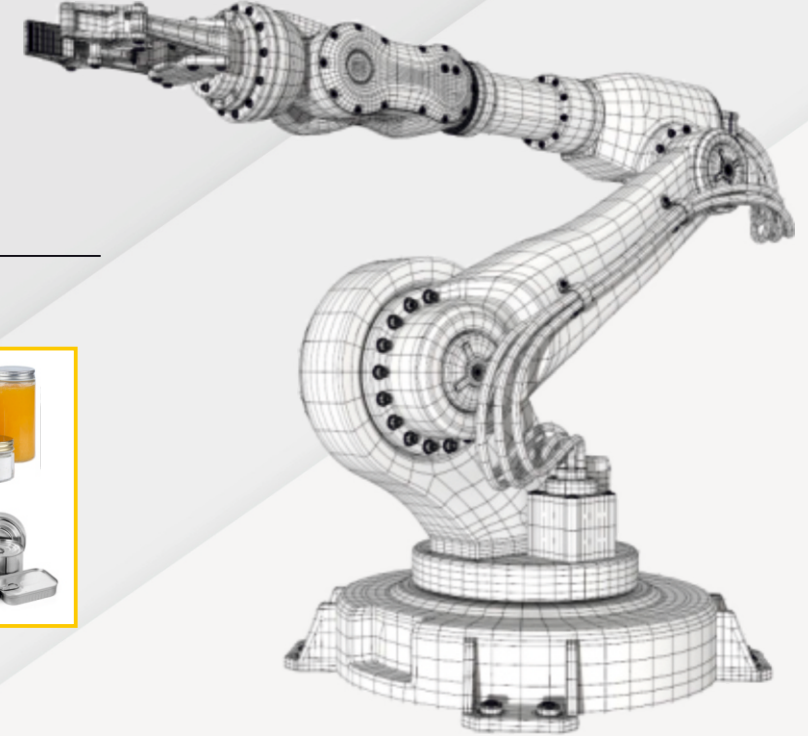

Robotik Uygulama Ataçmaları ve Kullanım Alanları

19 lt. Damacana Ataçmanı



- 19 lt. PET Damacana Paletleme
- 19 lt. Cam Damacana ve Plastik Sepet Paletleme - Palet Bozma
- 19 lt. PC Damacana Paletleme - Palet Bozma

Torba Ataçmanı



- Torba Şeklinde Paketlenmiş Ürün
- Kedi - Köpek Maması, Gübre, Yapı Kimyasalları, Çamaşır Deterjanı, Un vb.
- 5 Kg. - 50 kg. Arası Torba Paletmeye Uygunur.

Sıkma - Tutma Ataçmanı

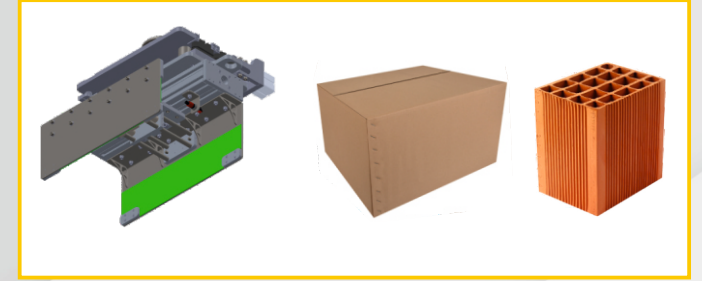

- Kolilenmiş Ürünlerin Paletlenmesi
- Su, Bisküvi, Şeker, Atıştırmalıklar, Temizlik Ürünleri, Farmakolojik ve Kozmetik Ürünler, kısaca bir kolinin içine girebilecek bütün ürünlerin paletlenmesi

Teneke Ataçmanı



- 1lt. - 20 lt. Teneke Paletleme - Palet Bozma
- Yemeklik Yağ, Makine Yağı, Temizlik Ürünleri, Çeşitli Asidik ve Bazik Ürünler, Çeşitli Kimyasallar vb.

Bidon Taşıma Ataçmanı

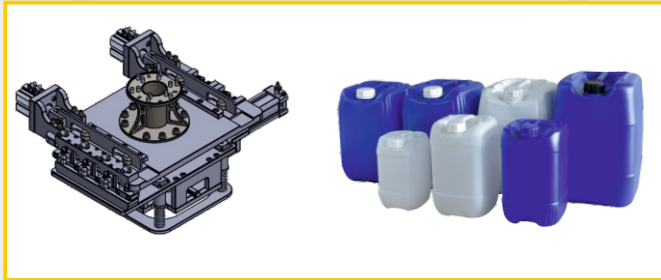

- 1lt. - 25 lt. Bidon Paletleme - Palet Bozma
- Çeşitli Yağlar, Çeşitli Kimyasallar, Çeşitli Asidik ve Bazik Ürünler, Bidonla Taşınan Tozlar vb.

Çok Amaçlı Çatal Ataçmanı



- Koli, Kağıtla Paketlenmiş Hassas Ürünler, Şrinklenmiş Ürünler
- Bir çok üründe kullanılması mümkündür. Özellikle taşıdığı ürünlere herhangi zarar verecek bir baskı uygulamaması nedeni ile hassas paketli ürünlerde kullanılır.

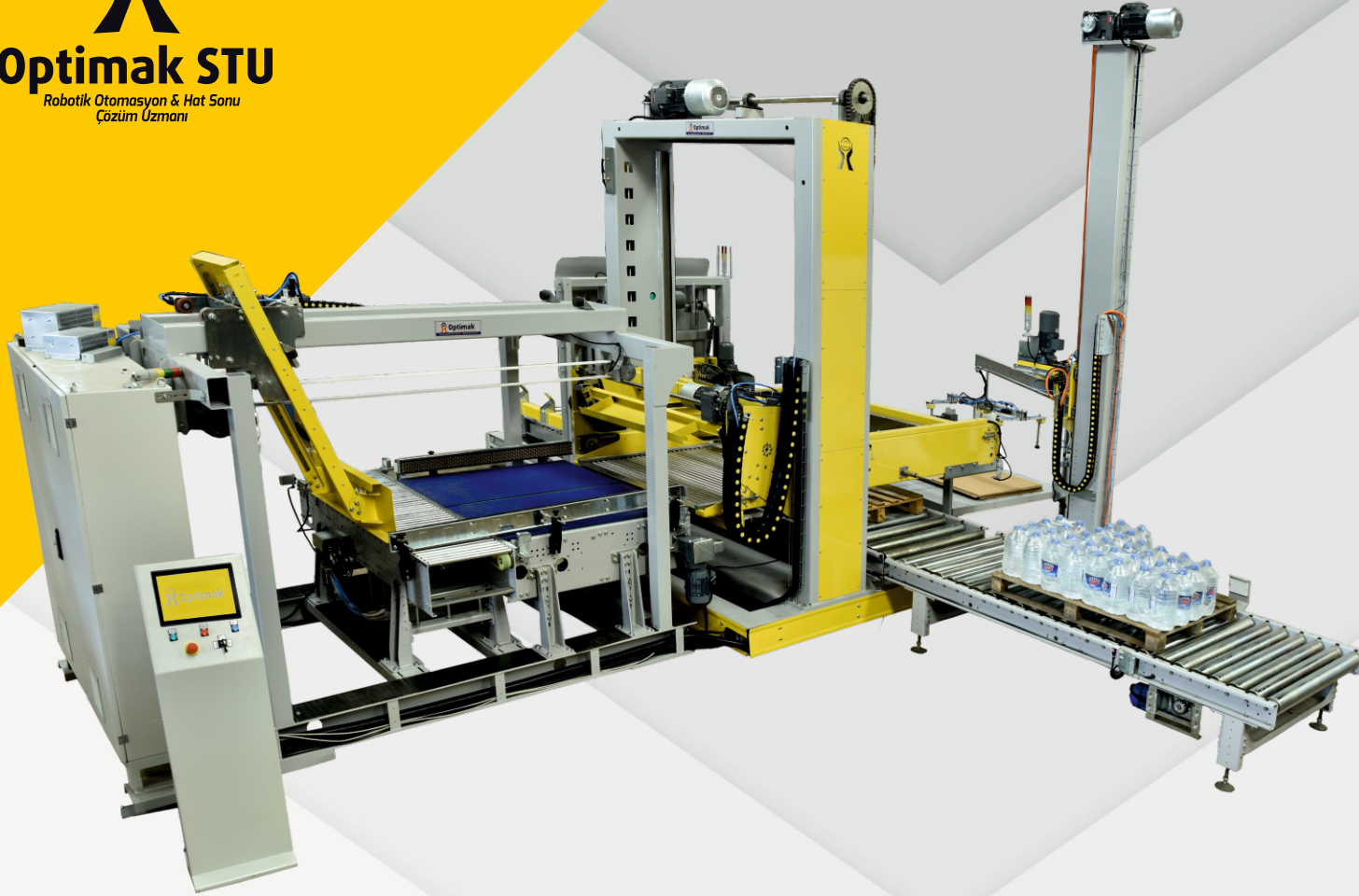

ÖRNEK PALLETİZER
VİDEOLARI İÇİN
KARE KODU OKUTUN.

Palletizer

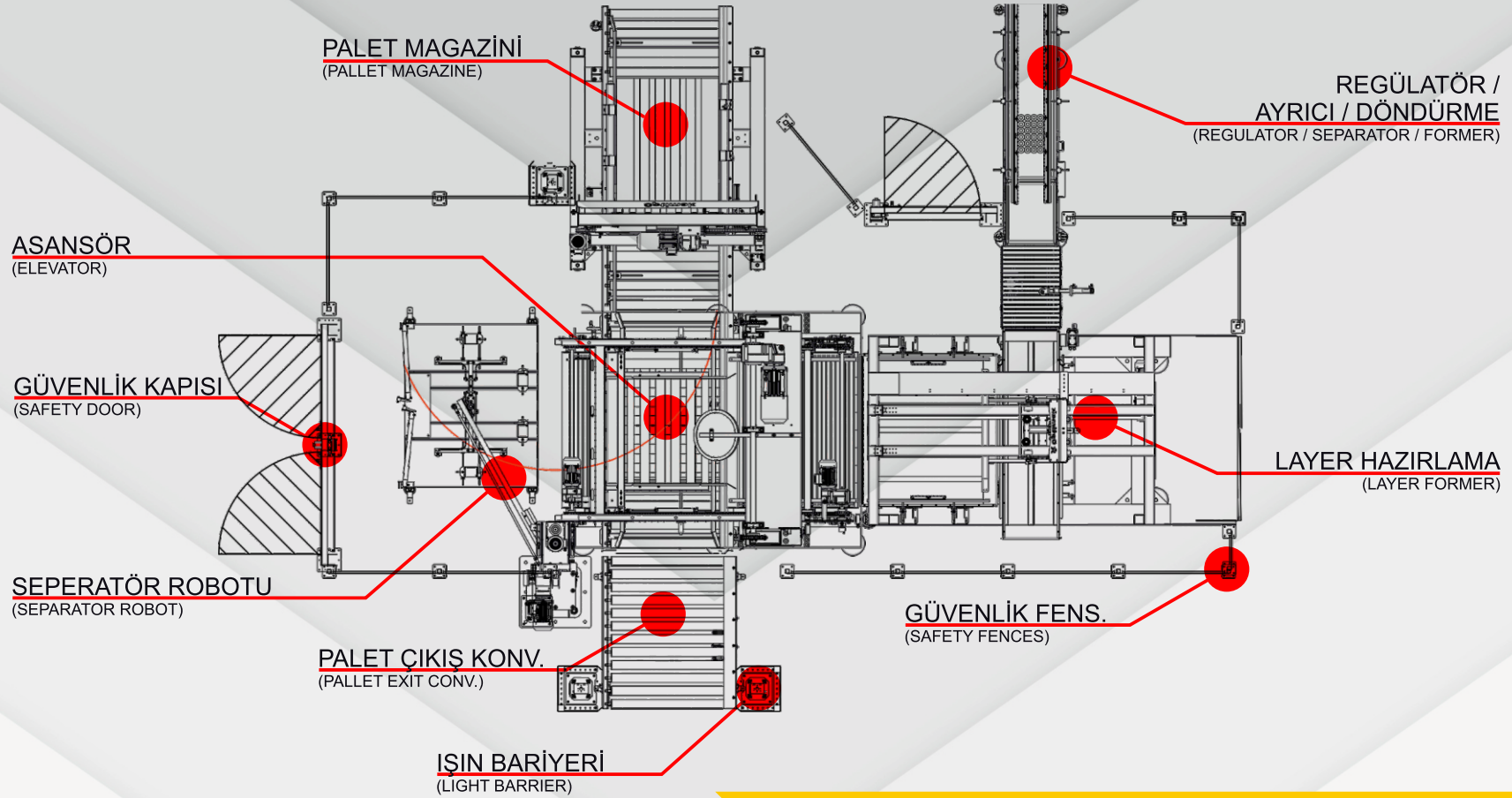

Palletizer Yardımcı Elemanları

PALET MAGAZİNİ



SEPERATÖR ROBOTU

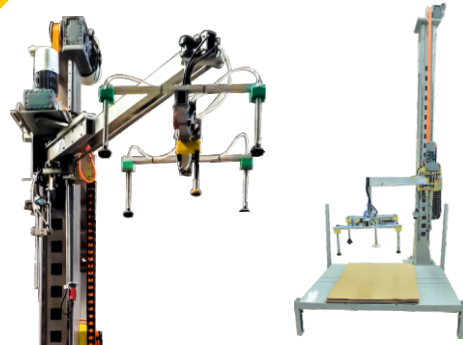

ROBOBOX



Streç Sarma Sistemleri



STREÇ SARMA
SİSTEMLERİ
VİDEOLARI İÇİN
KARE KODU
OKUTUN

20 palet/saat
OWRAP T20-A2



20 palet/saat
OWRAP TR20-A2



20 palet/saat
OWRAP ARM 20-A2



30 palet/saat
OWRAP ARM 30

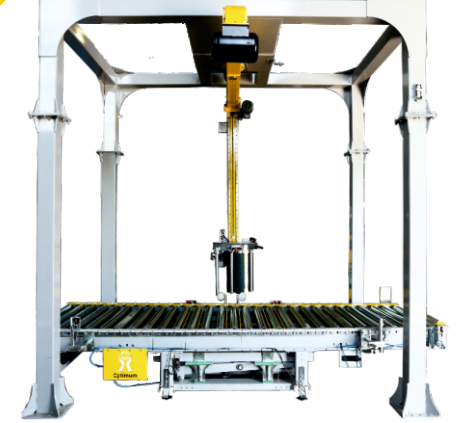

40 palet/saat
OWRAP ARM 40



60 palet/saat
OWRAP ARM 60



20 palet/saat
OWRAP CON 20

- 5 Derece



30 palet/saat
OWRAP CON 30

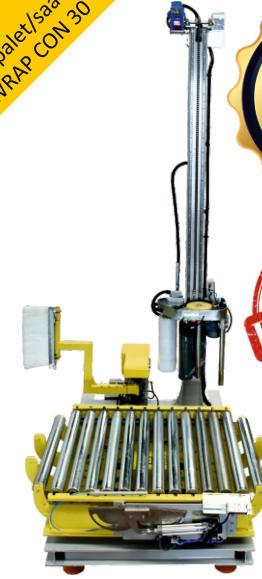

OWRAP ARM Streç Sarma Sistemi



TKY SİSTEMİ
(AUTO - BIND,CUT & SEAL)

GÜVENLİK KAPISI
(SAFETY DOOR)

TOP SHEET

DÖNER KOL
(ROTARY ARM)

ŞASE
(CHASIS)

PALET ÇIKIŞ KONV.
(PALLET EXIT CONV.)

PALET GİRİŞ KONV.
(PALLET IN. CON.)

İŞIN BARIYERİ
(LIGHT BARRIER)

AÇICI KAFA VE ASANSÖR
(CARRIAGE & ELEVATOR)

KÖRÜKLÜ KONVEYÖR
(PALLET LIFTING CONVEYOR)

GÜVENLİK FENİSİ
(SAFETY FENCES)

KÖŞE KARTON KOYMA SİSTEMİ
(CORNER PROTECTOR APPLICATOR)

Streç Sarma Yardımcı Elemanları

TOP SHEET LAYER



STREÇ AKTARMA



BARKOD - QR KOD



Palet Taşıma Konveyörleri

Zincirli Konveyör



Zincirli Döner Konveyör

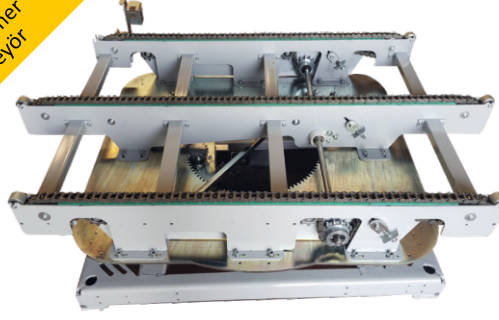

Modüler Bantlı Konveyör



Rulolu Konveyör



Rulolu Döner Konveyör



Rulolu Zemin Konveyörü



Shuttle Döner Konveyör



Transpalet Zemin Konveyörü



Shuttle Tipi Palet Taşıma Konveyörü



Palet Taşıma Konveyörleri

Modüler Bantlı
Döner Konveyör



Zincirli Kartezyen
Döner Konveyör



Transpalet
Liftli Konveyör

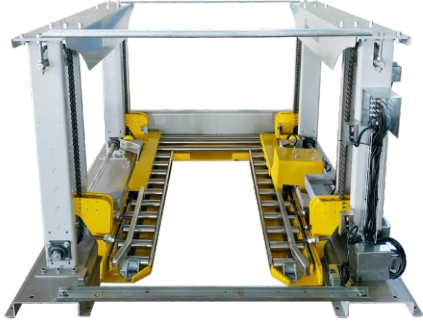

Zincirli
Kartezyen Konveyör



Palet Asansör Sistemleri

Palet Taşıma
Asansör Sistemi



**KONVEYÖR
SİSTEMLERİ
VİDEOLARI İÇİN
KARE KODU
OKUTUN.**

Ürün Taşıma Konveyörleri

Inox Bantlı
Konveyör



PVC Bantlı
Konveyör

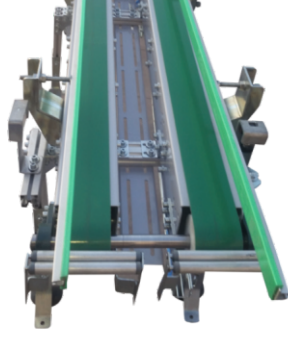

Rulolu
Akümülayon
Konveyörü



Boncuklu
Akümülayon
Konveyörü

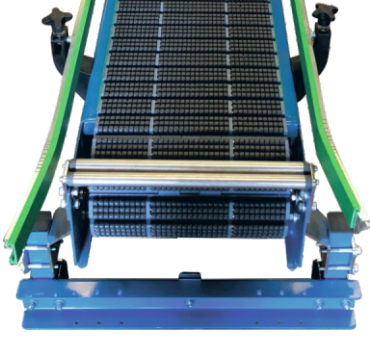

90° Asetal
Bantlı Konveyör



90° Kısa Dönüşü
Modüler Bantlı
Konveyör



Modüler Bantlı
Konveyör

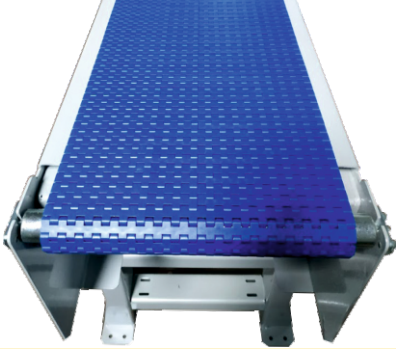

Asetal Tab
Konveyör



PVC BANTLI
KONVEYÖR

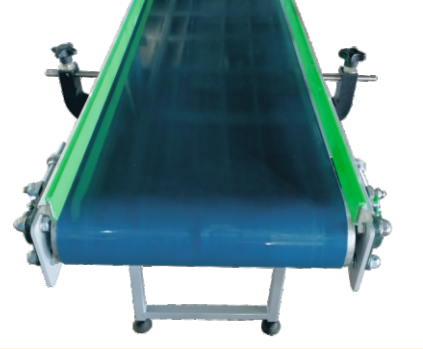

Işın Bariyeri



Güvenlik Kapsi



Sürgülü Güvenlik Kapsi

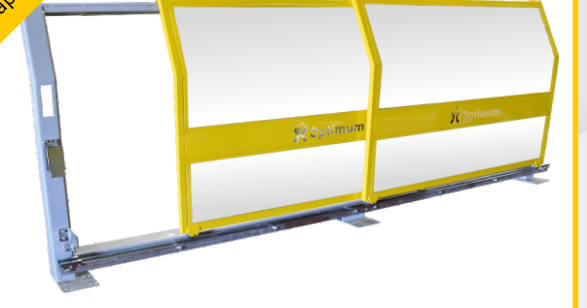

Forklift Bariyeri



Güvenlik Fensleri



Güvenlik Kapsi



Sertifika ve Belgelerimiz

ISO KALİTE BELGELERİMİZ

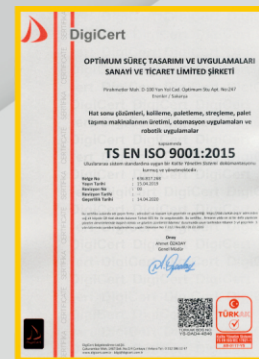

YERLİ MALİ BELGELERİMİZ



CE SERTİFİKALARI



Üye Olduğumuz Dernek Ve Odalar



Fuar Takvimimiz



Referanslarımız



Örnek Proje Çizimleri

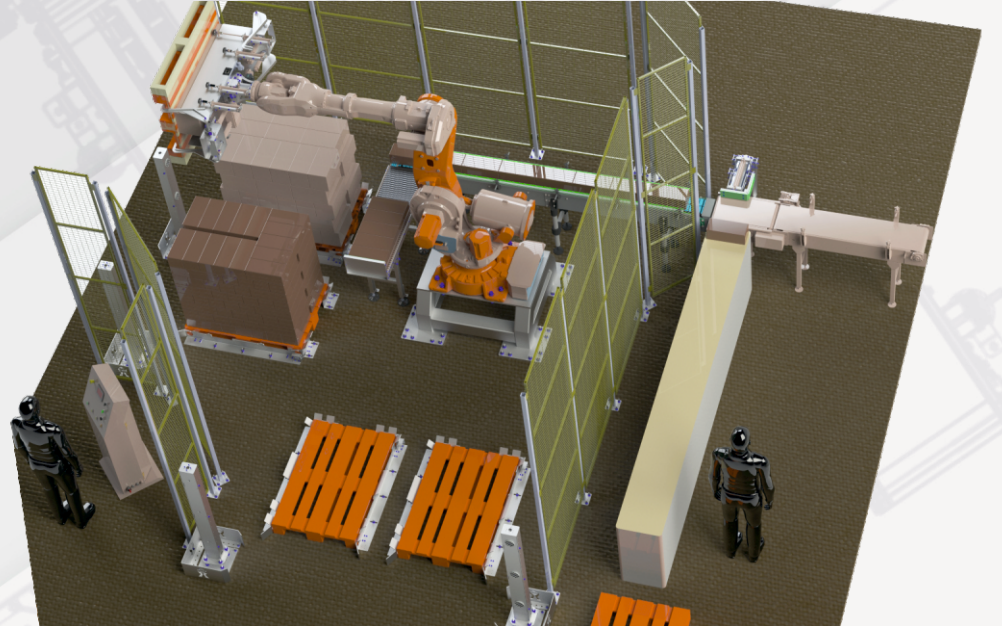
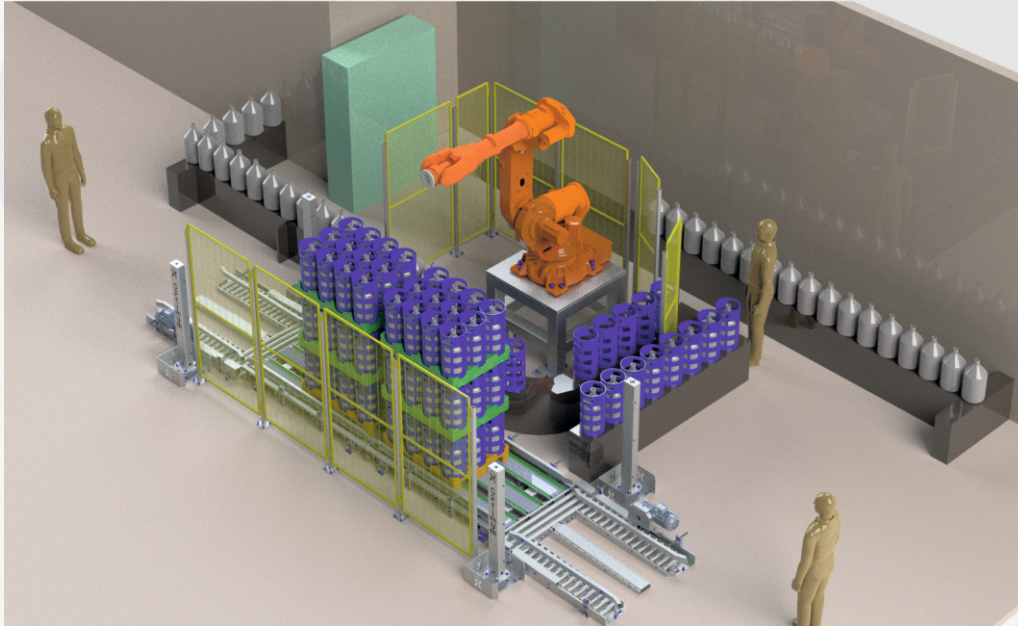
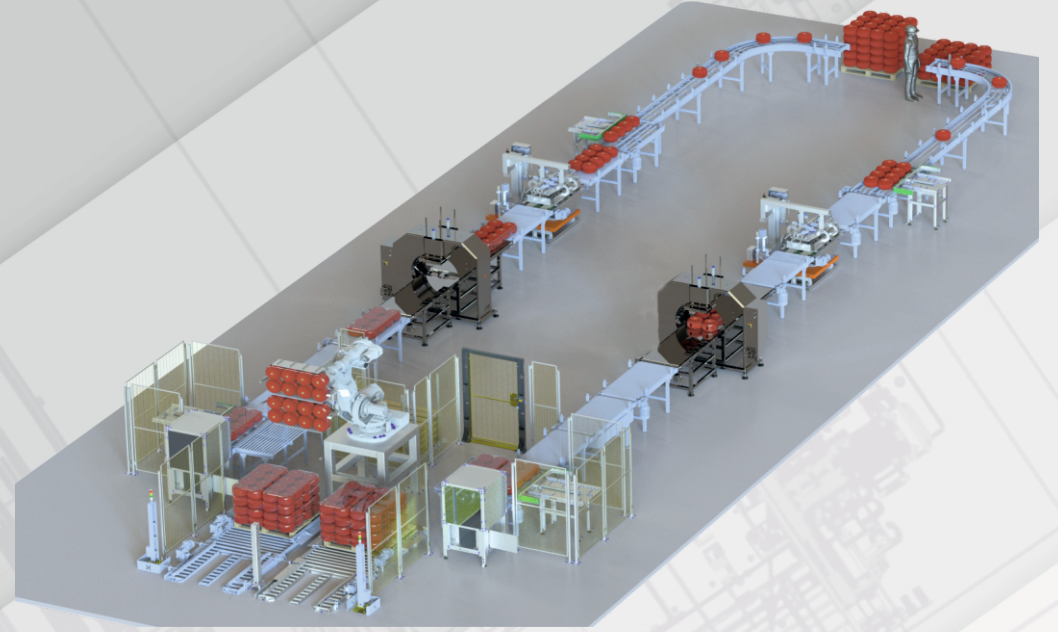
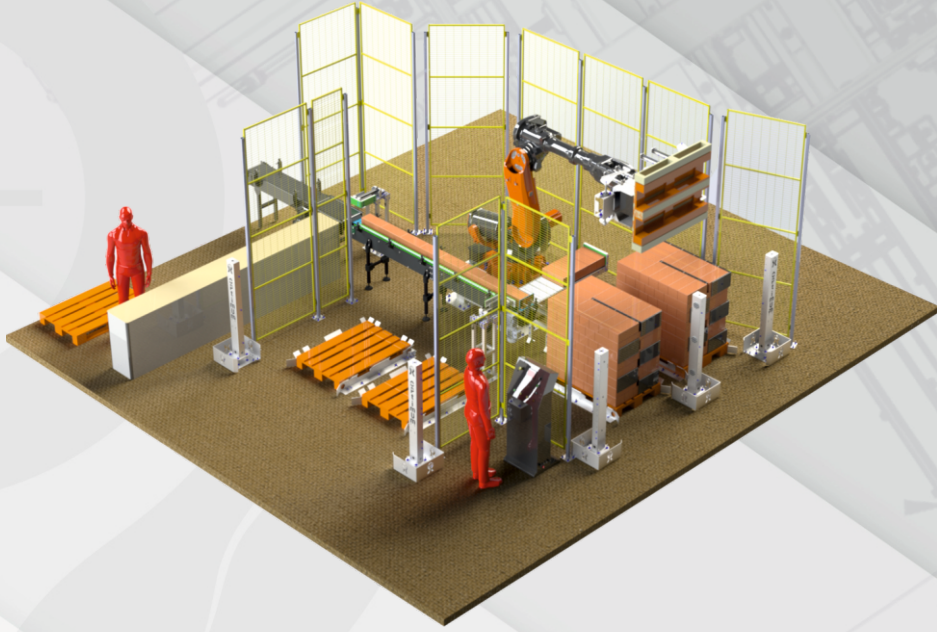

ENDÜSTRİ 4.0 UYGULAMALARI

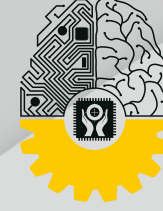

Optimum STU
AR-GE Merkezi

- BARKOD - KAREKOD
- AĞIRLIK ÖLÇÜM
- GÖRÜNTÜ İŞLEME
- PLC -P/C ENTEGRASYONU (MRP)
- RFID - BEACON
- DATA ANALİZ
- AGV
- SİZE ÖZEL PROJE UYGULAMALARI
- GÖMÜLÜ SİSTEMLER

